

12/2014 DG394\_00 REV00

# BISAZZA

CERAMICA

**Bisazza**  
36075 Alte, Vicenza Italia  
Tel. +39 0444 707511  
Fax +39 0444 492088  
[www.bisazza.com](http://www.bisazza.com)

COLLEZIONE  
ANTONIO CITTERIO PATRICIA VIEL

COLLEZIONE  
ANTONIO CITTERIO PATRICIA VIEL



**Antonio Citterio e Patricia Viel firmano la prima collezione in gres fine porcellanato per Bisazza, declinata in 3 linee: Origini, Acromi e Trame.**

I due colori assoluti di Origini - il bianco e il nero - presentano una superficie materica e ricca. Di sobria eleganza e armonia cromatica, la linea Acromi si ispira ai colori della natura ed è articolata in otto nuance.

Trame è una collezione di "tappeti" declinata in quattro proposte, Sahara, Stripes, Kirgil Sand e Madras, dallo stile essenziale e rigoroso. Nasce dall'accostamento delle diverse tonalità di Acromi, una linea in gres fine porcellanato, abbinata al mosaico o accuratamente decorata sulla superficie. Frutto di un'intuizione da parte di Antonio Citterio e Patricia Viel e di una ricerca tecnica intrapresa da Bisazza, queste soluzioni decorative per i pavimenti si rivelano essere delle collezioni raffinate per uno spazio contemporaneo.

"... Fare questo progetto con Bisazza, portatore di eccellenza nella cultura del decoro frutto della mano dell'uomo, significava associare al materiale di pavimentazione, attraverso il decoro, una specifica geometria, uno spirito dello spazio architettonico, l'espressione di una sua natura formale. L'inclusione del tappeto come disegno del modulo, utilizzando il tema della piastrella come trama e ordito di un telaio, è stata una intuizione immediata.

"...Origini rappresenta in sé la capacità di Bisazza di infondere nella ceramica uno stile riconoscibile, nel quale le materie tecniche, rigorose, volutamente impoverite offrono una occasione di delicata bellezza..."

... Il progetto della linea Acromi rappresenta in sé la capacità di Bisazza, nella contaminazione delle tecniche e nella scienza profonda delle cromie, di infondere nella ceramica uno stile riconoscibile. Il progetto dei decori e dei tappeti della collezione Trame offre a queste materie tecniche, rigorose, volutamente impoverite, una occasione di delicata bellezza.

Intenzionalmente primitivi, ingenui, eco di pura manualità legata alla cultura degli elementi e non dei linguaggi, il progetto Trame è testimonianza che la pura intenzione di bellezza, la ricerca di una armonia, di una compiuta forma rende arte tutto quello che l'uomo fa."

**Antonio Citterio and Patricia Viel design their first collection of fine porcelain ceramic for Bisazza including three product lines: Origini, Acromi and Trame.**

*Earthy textures and two absolute colors - black and white – strongly define the Origini collection. The elegant Acromi line draws inspiration from the most graceful colors of nature and comes in eight nuances.*

*Trame is an innovative flooring concept of tile "carpets" available in four minimalist designs: Sahara, Stripes, Kirgil Sand and Madras. The collection is the outcome of harmonious color combinations of fine porcelain ceramic tiles from the Acromi series adorned with mosaic inlays or various surface decorations.*

*The vision for the Trame collection began as a flash of inspiration for Antonio Citterio and Patricia Viel, and through detailed technical research and testing by Bisazza, these new decorative floorings now offer unique and refined solutions for contemporary spaces.*

*"... Embarking on a project with Bisazza, a name synonymous with excellence in handmade décor, means using decorative materials to give floorings a specific geometry, a spirit of architectural space, and an expression of its formal nature. Utilizing the carpet as the design concept for the collection, with tile replacing the traditional threads used for the warp and weft, was an immediate intuition.*

*... The Acromi and Origini projects represent Bisazza's ability to instill a signature style in ceramics through the cross-fertilization of techniques and a deep knowledge of colors. The Trame collection gives these strong, purposely humble materials a chance to be delicately beautiful.*

*Intentionally primitive and raw, and echoing a genuine handmade craftsmanship linked to a culture of the elements rather than language, the ceramic carpet project is a testament to the fact that by simply aspiring to beauty and pursuing harmony in form-making, anything that is done by man can become art."*

Antonio Citterio Patricia Viel

ORIGINI



gres fine porcellanato  
fine porcelain stoneware  
grès cérame  
Feinsteinzeug  
gres porcelánico

80 x 80 cm - 31 1/2" x 31 1/2"  
80 x 40 cm - 31 1/2" x 15 3/4"  
40 x 40 cm - 15 3/4" x 15 3/4"



**CENERE**



**LAVA**



**CENERE**

ACROMI

gres fine porcellanato  
fine porcelain stoneware  
grès cérame  
Feinsteinzeug  
gres porcelánico

80 x 80 cm - 31 1/2" x 31 1/2"  
80 x 40 cm - 31 1/2" x 15 3/4"  
40 x 40 cm - 15 3/4" x 15 3/4"

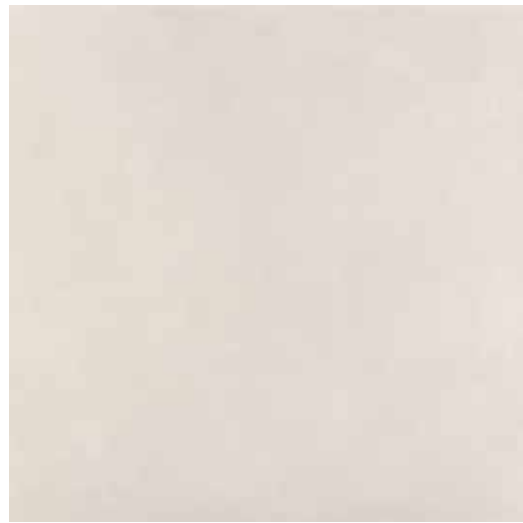

**CALCE**



**CALCARE**



**CAOLINO**



**CEMENTO**



**MAGNESIO**



**SILICIO**

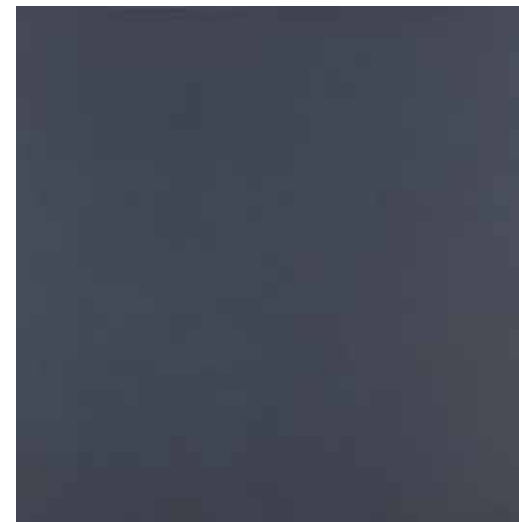

**OSSIDO**



**PECE**



## TRAME

i tappeti Trame sono disponibili in tutti i colori della collezione Acromi / Trame carpets are available in all the colours of the Acromi collection / les tapis Trame sont disponibles dans toutes les couleurs de la Collection Acromi / die Teppiche Trame sind in allen Farben der Kollektion Acromi erhältlich / las alfombras Trame están disponibles en todos los colores de la Colección Acromi

ceramiche in gres fine porcellanato con inserti in mosaico di smalto  
 fine porcelain ceramic tiles with enamel mosaic inlays  
 grès fin cérame avec incrustations en mosaïque d'émail  
 Feines Feinsteinzeug mit Einsätzen aus Emaille-Mosaiken  
 gres porcelánico fino con aplicaciones de mosaico de esmalte

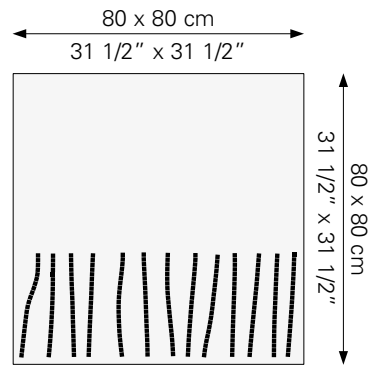
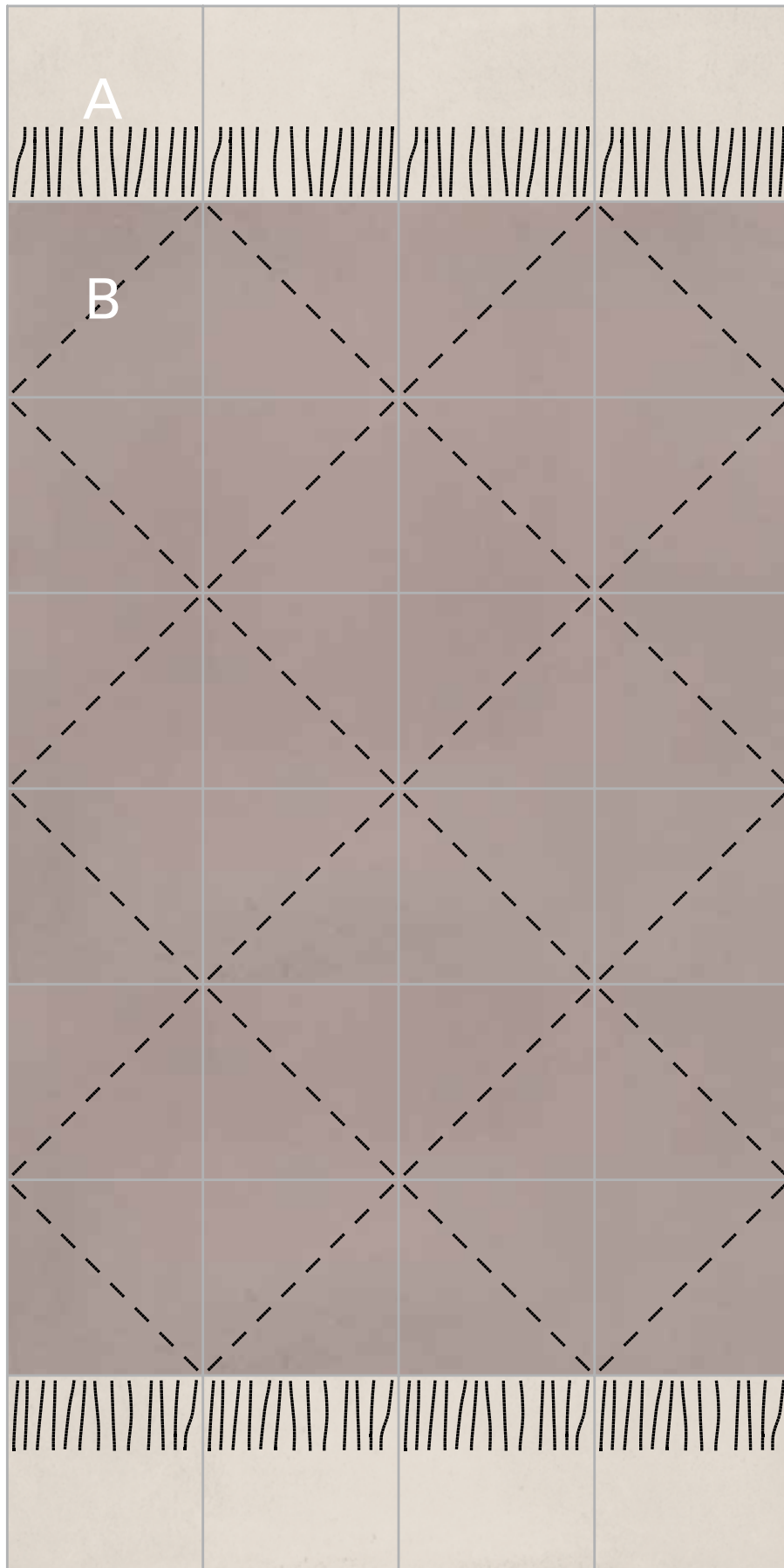

A



B



C

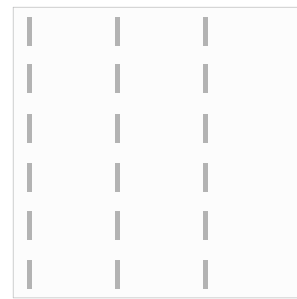

D

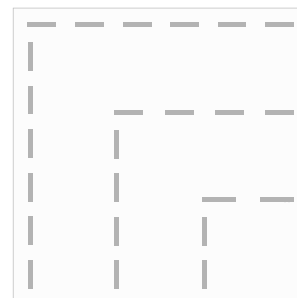

E



**SAHARA RHOMBUS**  
 Calce, Caolino

**SAHARA RHOMBUS**  
 Calcare



ceramiche in gres fine porcellanato con inserti in mosaico di smalto  
 fine porcelain ceramic tiles with enamel mosaic inlays  
 grès fin cérame avec incrustations en mosaïque d'émail  
 Feines Feinsteinzeug mit Einsätzen aus Emaille-Mosaiken  
 gres porcelánico fino con aplicaciones de mosaico de esmalte

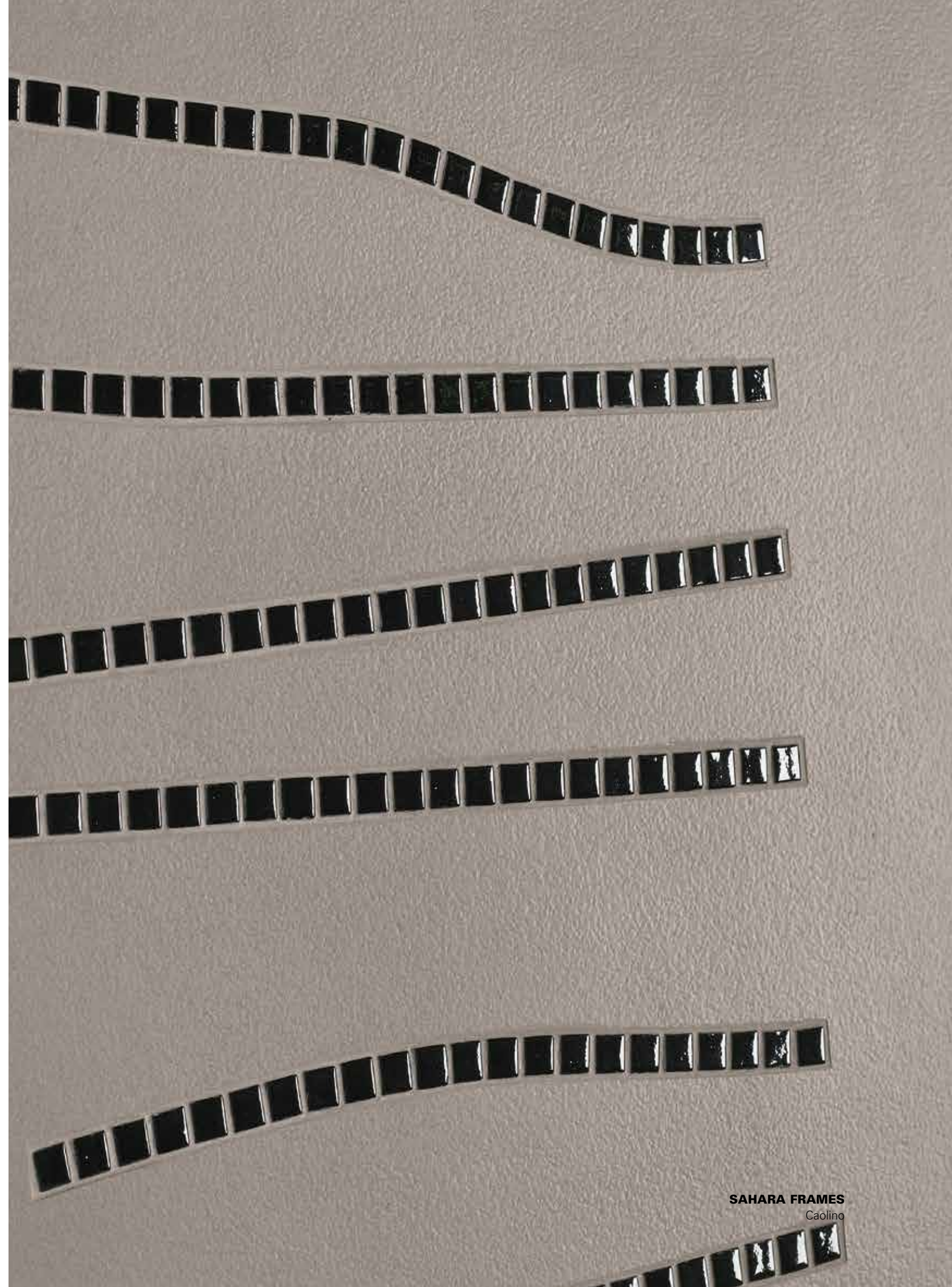
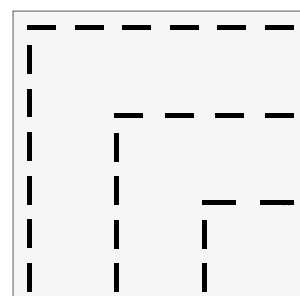
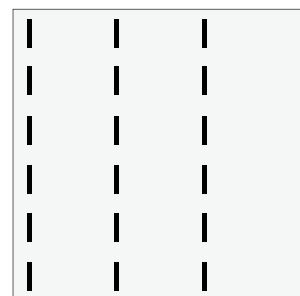
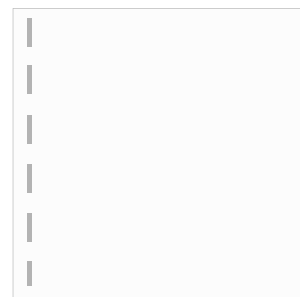
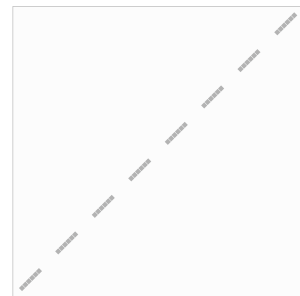
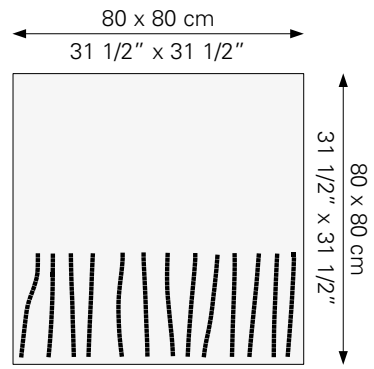
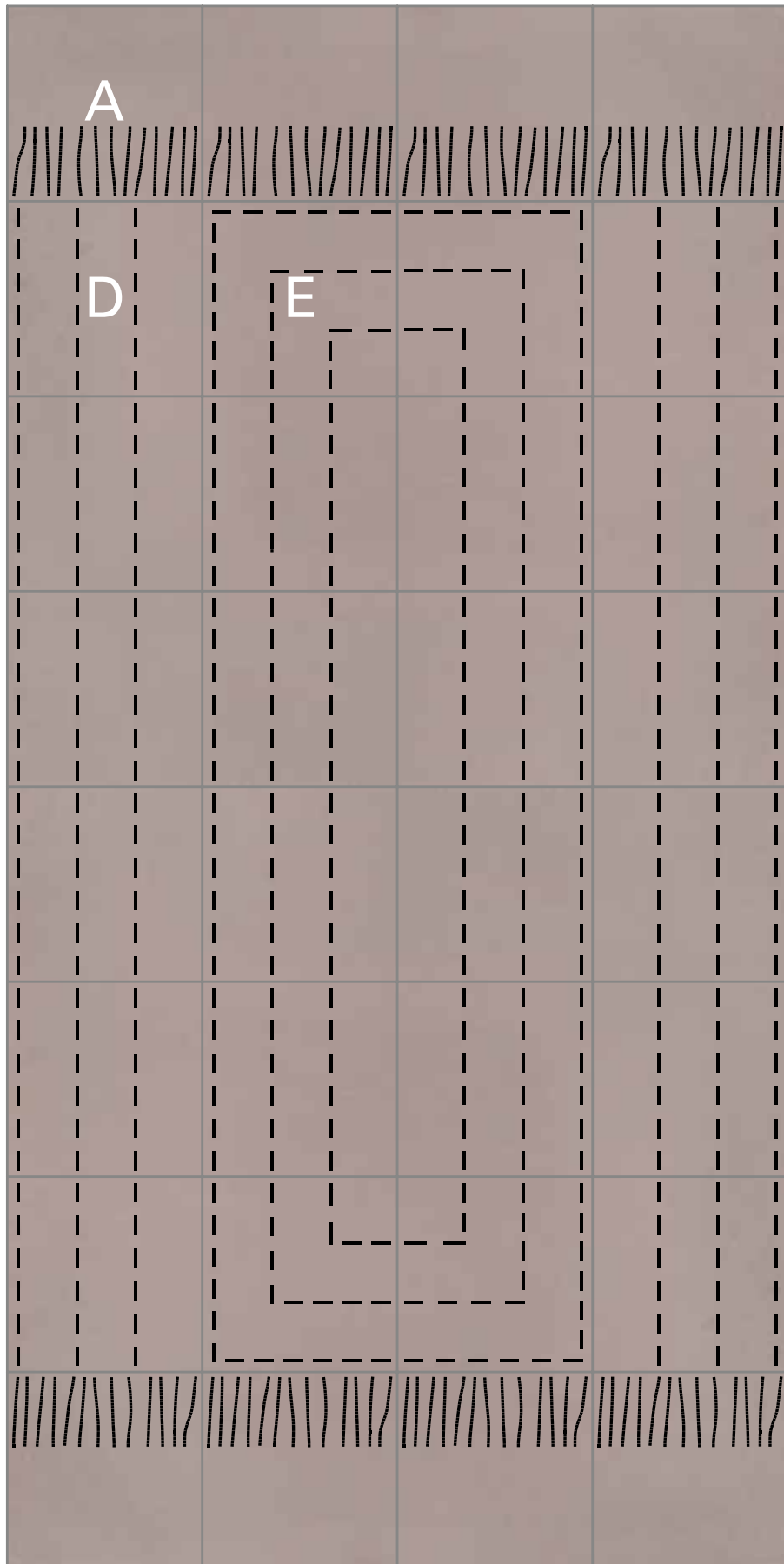

ceramiche in gres fine porcellanato con inserti in mosaico di smalto  
 fine porcelain ceramic tiles with enamel mosaic inlays  
 grès fin cérame avec incrustations en mosaïque d'émail  
 Feines Feinsteinzeug mit Einsätzen aus Emaille-Mosaiken  
 gres porcelánico fino con aplicaciones de mosaico de esmalte

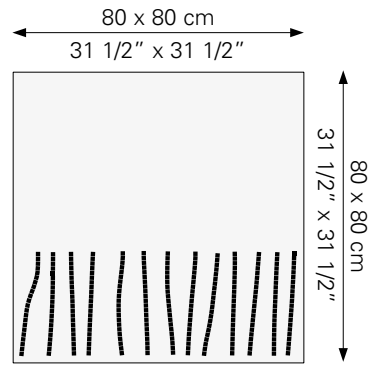
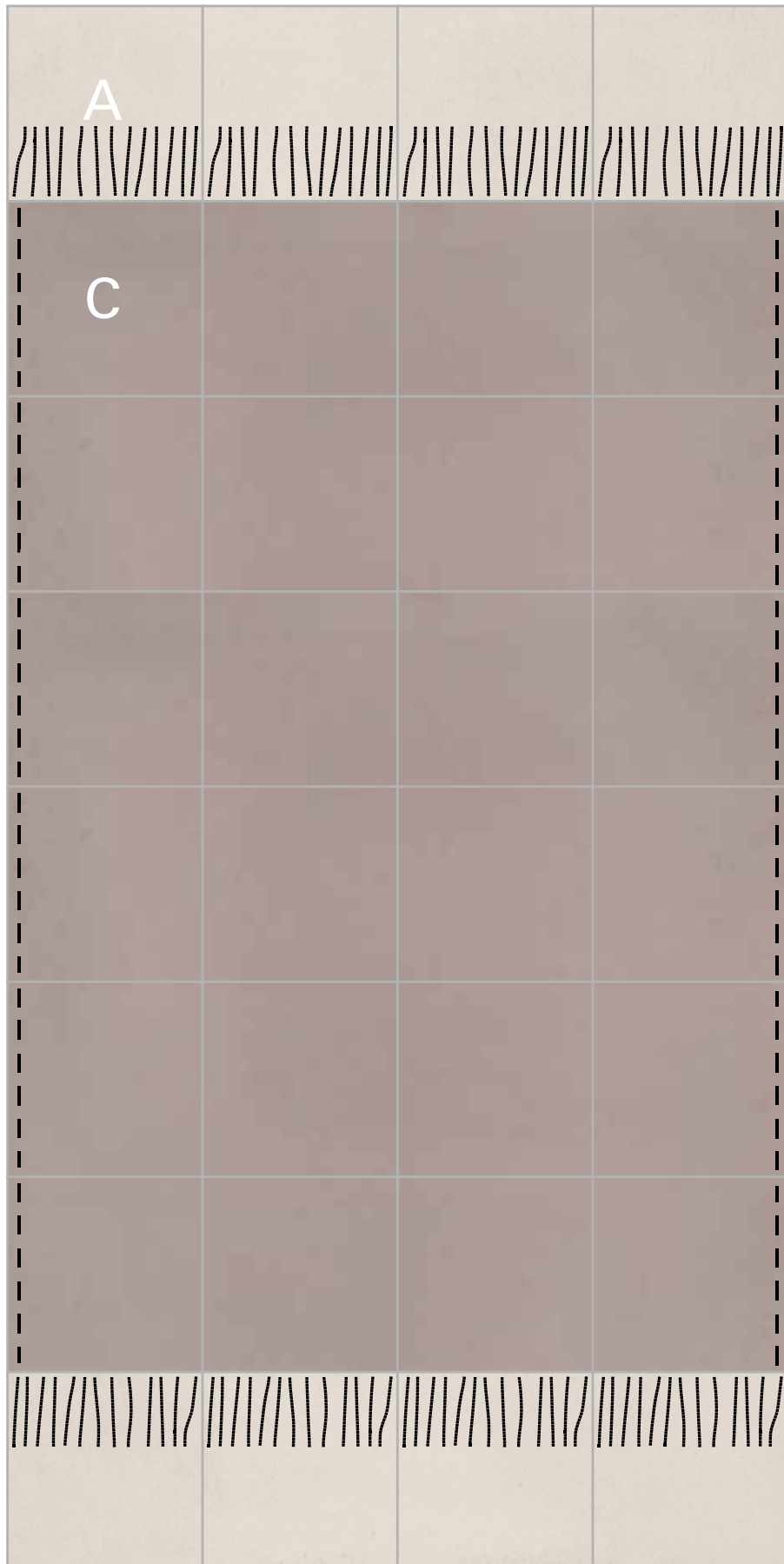

A



B



C

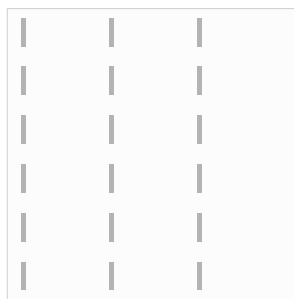

D

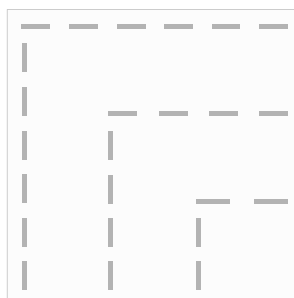

E



**SAHARA SELVAGE**  
 Calce, Caolino

**SAHARA SELVAGE**  
 Calcare



gres fine porcellanato  
fine porcelain stoneware  
grès cérame  
Feinsteinzeug  
gres porcelánico

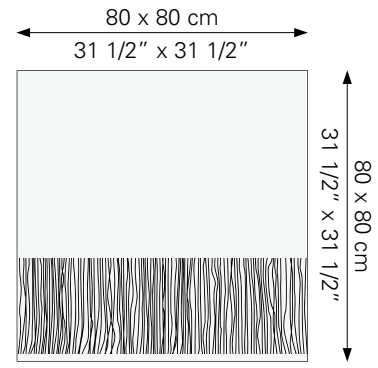
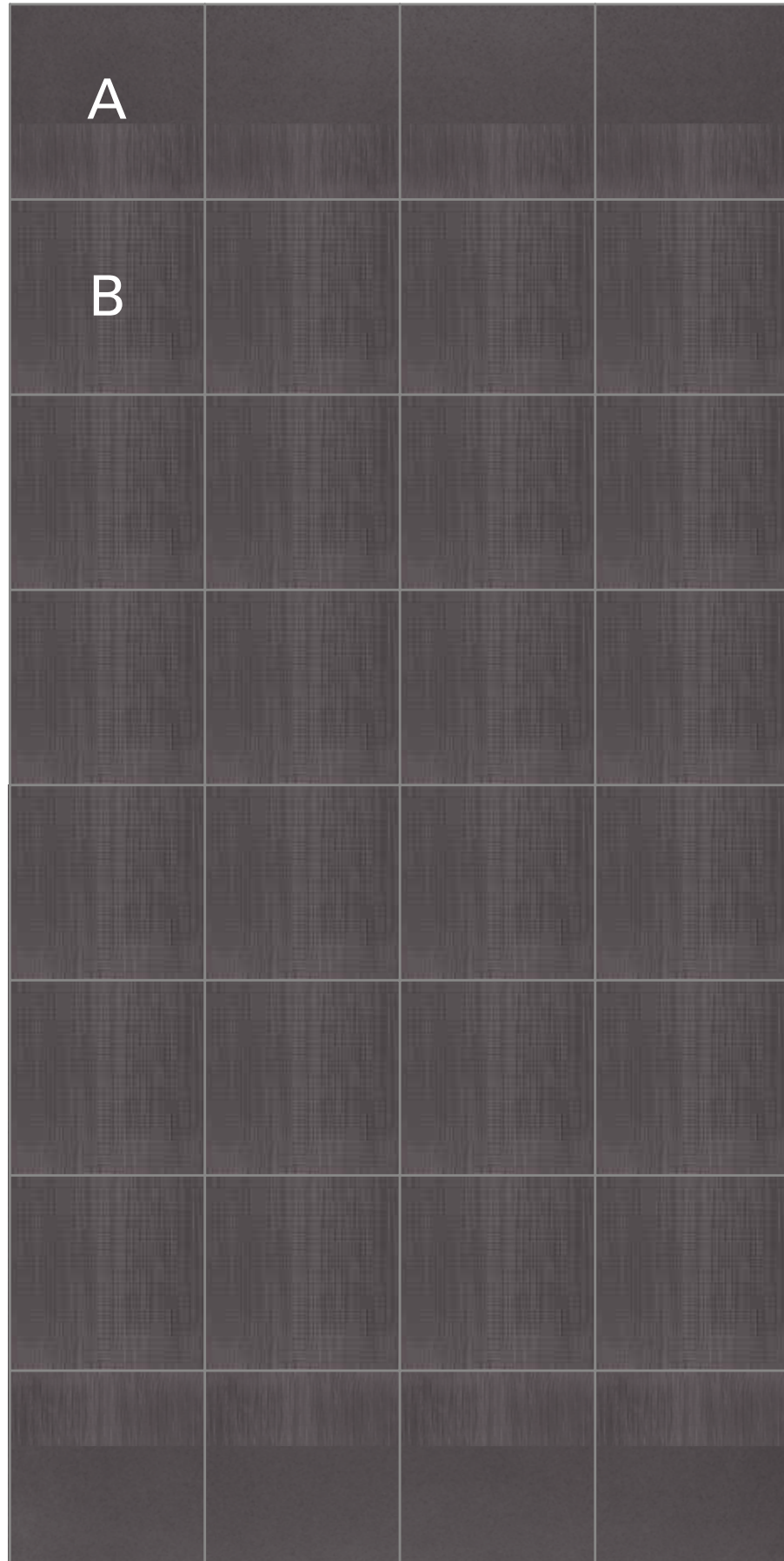

**A**

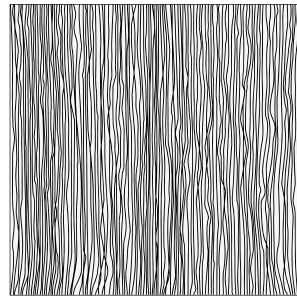

**B**



gres fine porcellanato  
 fine porcelain stoneware  
 grès cérame  
 Feinsteinzeug  
 gres porcelánico

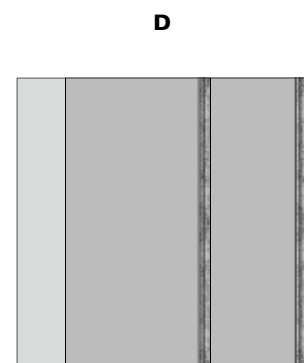
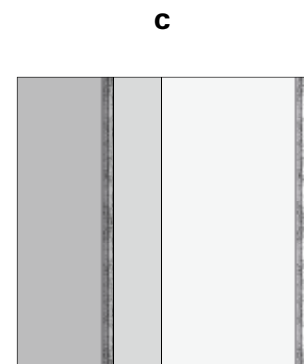
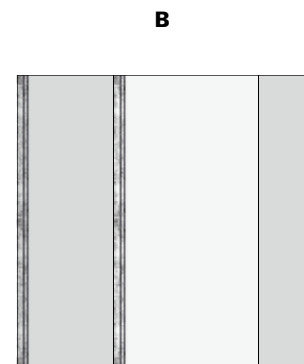
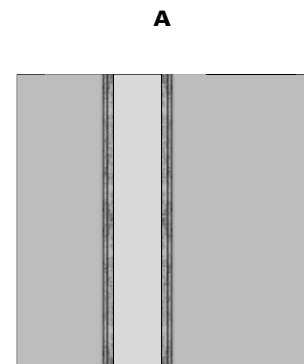
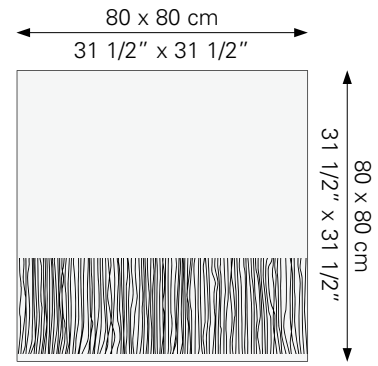
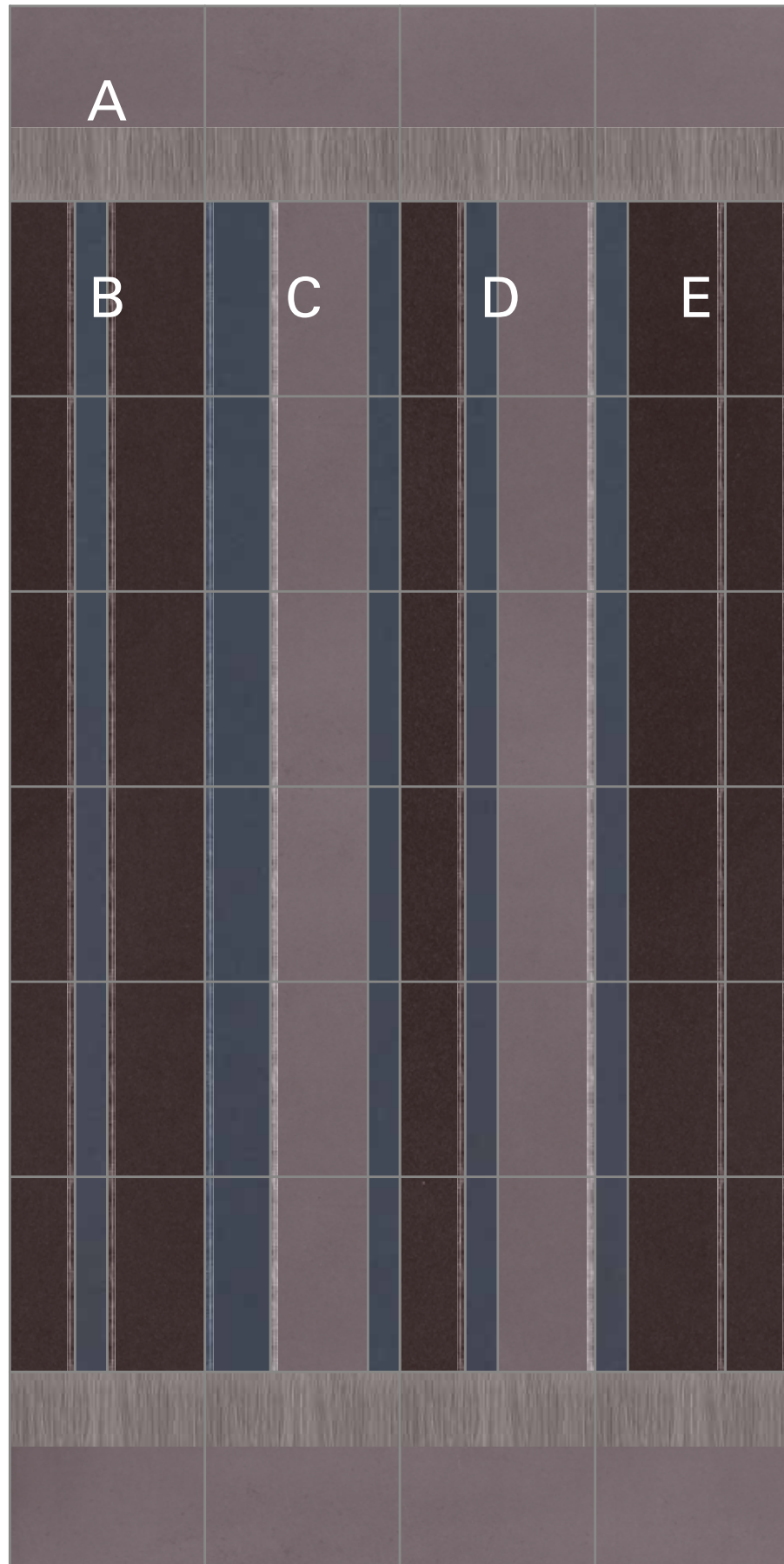

**STRIPES**  
 Pece, Ossido, Magnesio



**STRIPES**  
 Pece, Ossido, Magnesio





gres fine porcellanato  
fine porcelain stoneware  
grès cérame  
Feinsteinzeug  
gres porcelánico

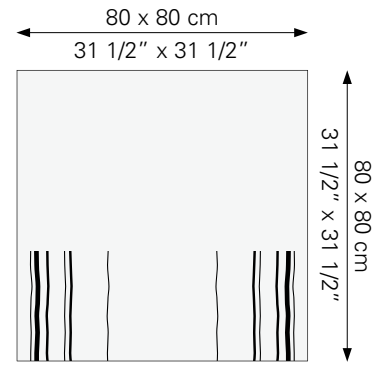
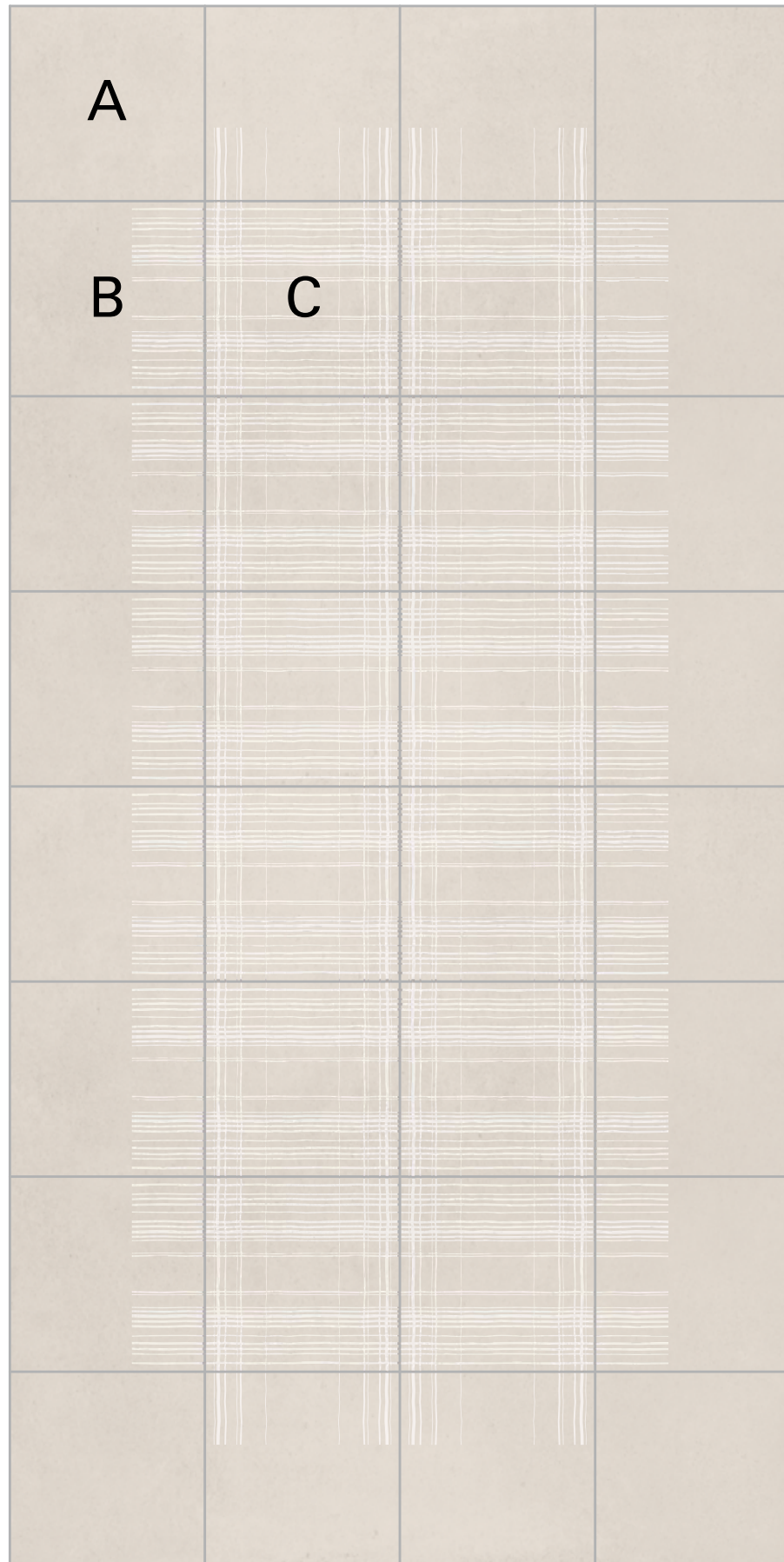

A



B

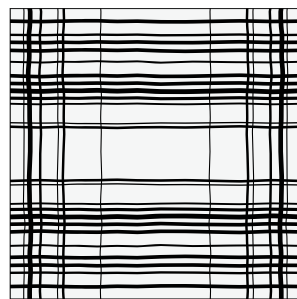

C

“ ... using decorative materials to give floorings a specific geometry, a spirit of architectural space. ”

Antonio Citterio Patricia Viel

AREA TECNICA  
TECHNICAL SECTION

## CARATTERISTICHE TECNICHE / TEST DATA

TEST	ISO	VALORE PRESCRITTO VALUES REQUIRED	ORIGINI	ACROMI - SAHARA - STRIPES - MADRAS KIRGIL SAND
Assorbimento d'acqua Water absorption	10545-3	≤ 0,5%	≤ 0,1%	≤ 0,1%
Lunghezza e Larghezza Length and width	10545-2	+/- 0,6% max +/- 2,0 mm max	Conforme alla norma Complies with the standards	Conforme alla norma Complies with the standards
Spessore Thickness	10545-2	+/- 5% max +/- 0,5 mm max	Conforme alla norma Complies with the standards	Conforme alla norma Complies with the standards
Rettilinearità degli spigoli Straightness of sides	10545-2	+/- 0,5% max +/- 1,5 mm max	Conforme alla norma Complies with the standards	Conforme alla norma Complies with the standards
Ortogonalità Orthogonality	10545-2	+/- 0,6% max +/- 2,0 mm max	Conforme alla norma Complies with the standards	Conforme alla norma Complies with the standards
Planarità Flatness	10545-2	+/- 0,5% max +/- 2,0 mm max	Conforme alla norma Complies with the standards	Conforme alla norma Complies with the standards
Carico di rottura Breaking load	10545-4		Conforme alla norma Complies with the standards	Conforme alla norma Complies with the standards
Sforzo di rottura Breaking strength	10545-4	≥ 1300 (Spessore ≥ 7,5 mm) ≥ 1300 (Thickness ≥ 7,5 mm)	Conforme alla norma Complies with the standards	Conforme alla norma Complies with the standards
Modulo di rottura Modulus of rupture	10545-4	≥ 35 N/sqmm	Conforme alla norma Complies with the standards	Conforme alla norma Complies with the standards
Resistenza all'urto Impact resistance	10545-5	> 0,55	Conforme alla norma Complies with the standards	Conforme alla norma Complies with the standards
Resistenza all'abrasione (PEI) Wear resistance (PEI)	10545-7	Min Classe 1; Max Classe 5 Min Class 1; Max Class 5	Conforme alla norma Complies with the standards	Classe 5 Class 5
Resistenza all'abrasione profonda Deep wear resistance	10545-6	V [cm <sup>3</sup> ] ≤ 175		Conforme alla norma Complies with the standards
Coefficiente di dilatazione termica lineare Thermal expansion coefficient	10545-8	≤ 9Mk <sup>-1</sup>	Conforme alla norma Complies with the standards	Conforme alla norma Complies with the standards
Resistenza agli sbalzi termici Resistance to thermal shock	10545-9		Conforme alla norma Complies with the standards	Resistente Resistant
Resistenza al gelo Frost resistance	10545-12		Conforme alla norma Complies with the standards	Conforme alla norma Complies with the standards
Resistenza ai prodotti chimici Chemical resistance	10545-13		Conforme alla norma Complies with the standards	Conforme alla norma Complies with the standards
Resistenza alle macchie Stains Resistance	10545-14	Min Classe 1; Max Classe 5 Min Class 1; Max Class 5	Classe 5 Class 5	Classe 5* Class 5
Resistenza allo scivolamento Antislip value	DIN 51130 DIN 51097 ASTM C 1028	Min R9 da A a C > 0,6 (asciutto e bagnato) > 0,6 (dry & wet)	A	R9 B > 0,6 (asciutto e bagnato) > 0,6 (dry & wet)

Origini: Gres porcellanato fine, ad impasto colorato, a doppio caricamento, UNI EN 14411 ISO13006 appendice G gruppo Bl. Rettificato Acromi - Sahara - Stripes - Kirgil Sand - Madras: gres porcellanato fine, ad impasto colorato, smaltato UNI EN14411 ISO13006 appendice G gruppo Bl. Rettificato

Origini: fine porcelain stoneware, coloured mix, double-loaded UNI EN14411 ISO13006 appendix G group Bl. Rectified Acromi - Sahara - Stripes - Kirgil Sand - Madras: fine porcelain stoneware, coloured mix, glazed UNI EN14411 ISO13006 appendix G group Bl. Rectified

\*Stripes - Kirgil Sand - Madras: Classe 3 - 4 / Class 3 - 4

## MISURE E PESI / WEIGHT AND DIMENSIONS

Formato Size	80x80 cm (798x798 mm)	80x40 cm (798x398 mm)	40x40 cm (398x398 mm)
Spessore Thickness	10,5 mm	10,5 mm	10,5 mm
Pezzi per scatola Pieces per box	2	4	6
Quantità per scatola Quantity per carton	1,28 m <sup>2</sup>	1,28 m <sup>2</sup>	0,96 m <sup>2</sup>
Peso Weight	24,38 kg/mq	24,38 kg/mq	24,38 kg/mq
Peso per scatola Weight per carton	31,20 kg	31,20 kg	23 kg
Scatole per pallet Cartons per pallet	40	24	31
Quantità per pallet Quantity per pallet	51,20 m <sup>2</sup>	30,72 m <sup>2</sup>	29,76 m <sup>2</sup>
Dimensioni paletta Pallet dimensions	cm 80x120x95h	cm 80x120x95h	cm 120x80x55h
Peso pallet Pallet weight	~ 1.248 kg	~ 749 kg	~ 967 kg

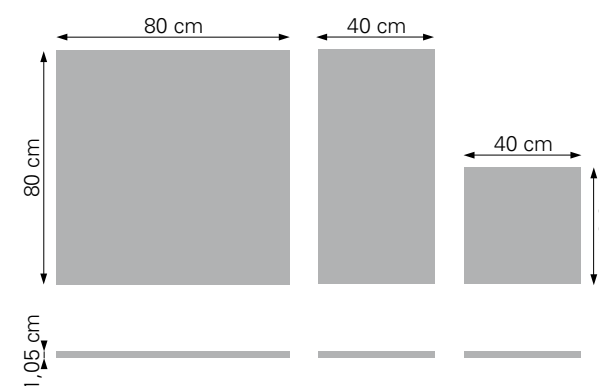

## BATTISCOPA / SKIRTING

Articolo Item	ORIGINI - ACROMI
Formato Size	80 x 9,5 x 1,05 cm
Unità d'ordine Order Unit	1 pezzo / piece



Foto Lorenzo Ceretta

Antonio Citterio Patricia Viel Interiors

Wolfgang Scheppe

photo Leo Torri

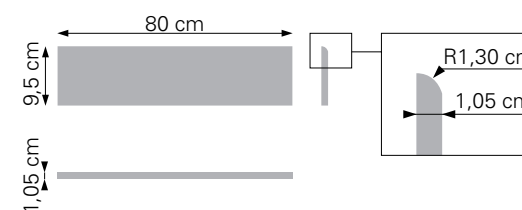
Progetto grafico Paolo Rinaldi

Claudia Carrarini

© Bisazza S.p.A.

tutti i diritti riservati / all rights reserved

