



02/2016 DO415_00 REV00

Bisazza
36075 Alte, Vicenza Italia
Tel. +39 0444 707511
Fax +39 0444 492088
www.bisazza.com

BISAZZA

BAGNO



BISAZZA

BAGNO

BISAZZA

BAGNO

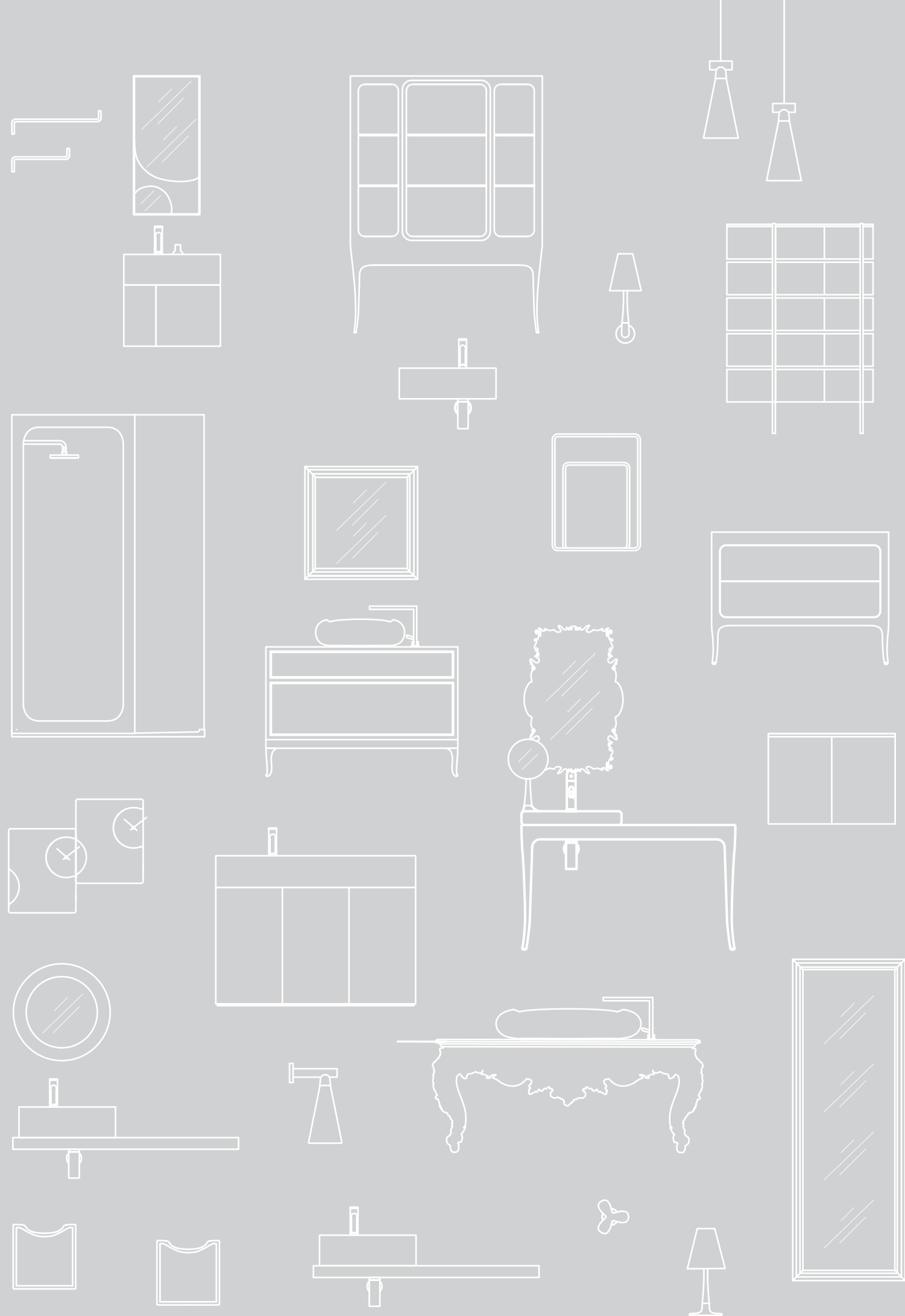

Bisazza amplia le sue proposte per la casa con la linea Bisazza Bagno. Tre collezioni, completamente distinte, ognuna con un proprio stile, espressione di ciascuno dei tre designer coinvolti in questo progetto: Jaime Hayon, Marcel Wanders e Nendo.

Bisazza widens its product offerings for home interiors with Bisazza Bagno. Three collections, each expressing the distinct style of the designers who have conceived them: Jaime Hayon, Marcel Wanders and Nendo.

7	The HAYON Collection
45	The WANDERS Collection
73	The NENDO Collection
99	<i>Area Tecnica / Technical Section</i>
137	<i>Manutenzione / Maintenance</i>



THE HAYON COLLECTION

design Jaime Hayon



"La collezione ricorda il glamour degli anni '30 - racconta il designer spagnolo - con un tocco scandinavo e forme femminili. L'eleganza è il tratto distintivo di questa originale collezione. L'ambiente del bagno è il più importante della casa, non deve essere celato, ma piuttosto mostrato. Una stanza da tenere aperta. Il bagno si trasforma in una stanza ricca di charme e stile, con una forte identità."

"The collection recalls the glamour of the 1930s - the Spanish designer says - with a Scandinavian touch and feminine shapes. Elegance is the main trait of this innovative collection. The bathroom is the most important room in the home and it should not be hidden. With this collection, it becomes an area you want to show, a place you can keep open. The bathroom becomes a stylish room, full of charm and style, with a strong identity."

Jaime Hayon





Console **Crocus 155 White**
Lavabo / washbasin **Bergamot White**
Miscelatore / mixer **Gentian 75 Copper**
Specchio / mirror **Dandelion 44 White**
Mensola / shelf **Sunflower White**
Appendiabiti / hanger **Primrose White**
Mobile contenitore a vetri / glass cabinet **Hyacinth 120 White**
Vasca / bathtub **Daffodil 205 White**
Coperchi / lids **Cornflower White**



Console **Asphodel 155 White**
 Lavabo / washbasin **Bergamot White**
 Miscelatore / mixer **Gentian 75 Chrome**
 Specchio / mirror **Dandelion 44 White**
 Lampada / lamp **Petunia White**
 Appendiabiti / hanger **Primrose White**



Top lavabo con cassettera /
 vanity top with hanging drawer **Amaranth White**
 Lavabo / washbasin **Bergamot White**
 Miscelatore / mixer **Gentian 75 Chrome**
 Specchio / mirror **Dandelion 44 White**
 Mensola / shelf **Sunflower White**



Top lavabo / vanity top **Daisy 155 White**
 Lavabo / washbasin **Bergamot White**
 Miscelatore / mixer **Gentian 75 Chrome**
 Mensola / shelf **Sunflower White**
 Specchio / mirror **Dandelion 44 White**



Console **Columbine 155 White**
 Lavabo / washbasin **Bergamot White**
 Miscelatore / mixer **Gentian 75 Chrome**
 Specchio / mirror **Dandelion 44 White**
 Lampada / lamp **Petunia White**
 Appendiabiti / hanger **Primrose White**
 Appendiabiti / hanger **Primrose Platinum**



Console **Cyclamen 140 White**
Lavabo / washbasin **Anemone White**
Lavabo / washbasin **Amaryllis White**
Miscelatore / mixer **Freesia 35**
Specchio / mirror **Lilac 90**



sopra / above
Console **Cyclamen 140 White**
Lavabo / washbasin **Azalea Platinum**
Miscelatore / mixer **Freesia 35**
Specchio / mirror **Lilac 90**
Lampada / lamp **Tansy Platinum**



sotto / below
Console **Cyclamen 140 Grey**
Lavabo / washbasin **Azalea White**



Console **Cyclamen 140 White**
Lavabo / washbasin **Azalea Gold**
Miscelatore / mixer **Freesia 35**
Specchio / mirror **Lilac 120**





Console **Cyclamen 65 White**
Lavabo / washbasin **Azalea White**
Miscelatore / mixer **Freesia 35**
Lampada / lamp **Tansy White**
Specchio / mirror **Dandelion 44 White**





Console **Cyclamen 65 Black**
Lavabo / washbasin **Anemone Black**
Miscelatore / mixer **Freesia 36**
Specchio / mirror **Dandelion 44 Black**



sopra / above
 Console **Columbine 155 Black**
 Lavabo / washbasin **Bergamot Black**
 Miscelatore / mixer **Gentian 75 Chrome**
 Specchio / mirror **Dandelion 128 Black**
 Mensola / shelf **Sunflower Black**
 Mobile contenitore a vetri / glass cabinet **Hyacinth 60 Black**
 Vasca / bathtub **Daffodil 205 Black**
 Coperchi / lids **Cornflower White**
 Miscelatore / mixer **Freesia 38**

destra e sotto (dettaglio) / right and below (detail)
 Console / table **Cyclamen 140 Black**
 Lavabo / washbasin **Anemone Platinum**
 Miscelatore / mixer **Freesia 35**
 Specchio / mirror **Dandelion 128 Black**





Console **Crocus 155 Black**
 Lavabo / washbasin **Bergamot Black**
 Miscelatore / mixer **Gentian 75 Copper**
 Specchio / mirror **Dandelion 44 Black**
 Mensola / shelf **Sunflower Black**



Console **Crocus 155 Black**
 Lavabo / washbasin **Bergamot Black**
 Miscelatore / mixer **Gentian 75 Copper**
 Specchio / mirror **Dandelion 128 Black**
 Lampada / lamp **Tansy Black**
 Appendiabiti / hanger **Primrose Black**



Console **Asphodel 80 Black**
 Lavabo / washbasin **Bergamot Black**
 Miscelatore / mixer **Gentian 75 Chrome**
 Specchio / mirror **Dandelion 44 Black**
 Lampada / lamp **Tansy Black**
 Mobile contenitore a vetri / glass cabinet **Hyacinth 60 Black**

destra / right
 Console **Columbine 80 Black**
 Lavabo / washbasin **Bergamot Black**
 Miscelatore / mixer **Gentian 75 Chrome**
 Specchio / mirror **Dandelion 44 Black**





Vasca / bathtub **Daffodil 205 White**
Coperchi / lids **Cornflower White**
Miscelatore / mixer **Freesia 39**
Specchio / mirror **Dandelion 44 White**



Vasca / bathtub **Daffodil 175 Grey**
Miscelatore / mixer **Freesia 38**



Cassettiera / drawer unit **Buttercup White**



Mobile contenitore a vetri / *glass cabinet* **Hyacinth 120 White**



- Console **Crocus 155 White**
- Lavabo / *washbasin* **Bergamot White**
- Miscelatore / *mixer* **Gentian 75 Copper**
- Specchio / *mirror* **Dandelion 44 White**
- Mensola / *shelf* **Sunflower White**
- Appendiabiti / *hanger* **Primrose White**
- Mobile contenitore a vetri / *glass cabinet* **Hyacinth 120 White**
- Vasca / *bathtub* **Daffodil 205 White**
- Coperchi / *lids* **Cornflower White**

Parete doccia / glass screen **Tuberose 120 Black**
Lastre in marmo / marble slabs **Mimosa 80 Black**
Piatto doccia / shower tray **Waterlily 160 Black**
Miscelatore doccia / shower mixer **Freesia 77**
Console **Columbine 155 Black**
Lavabo / washbasin **Bergamot Black**
Miscelatore lavabo / washbasin mixer **Gentian 75 Chrome**
Specchio / mirror **Dandelion 44 Black**





Parete doccia / glass screen **Tuberose 100 White**
Parete doccia / glass screen **Tuberose 80 White**
Piatto doccia / shower tray **Waterlily 160 White**
Miscelatore / mixer **Freesia 77**





Appendiabiti / hanger **Primrose Gold, Primrose White, Primrose Black, Primrose Platinum**



The Wanders Collection

design Marcel Wanders



“La collezione deriva il suo concept originario da una mia fantasia, fare il bagno immerso in una saponetta: l’apoteosi del pulito! Ho tenuto dentro di me quest’idea per molto tempo, fino a quando Bisazza non mi ha aiutato a realizzarla. La collezione è poi cresciuta e si è articolata in tre diverse linee, ognuna con una sua estetica ben definita, dall’antico fino all’architettura costruttiva. L’idea di presentare diverse epoche in un’unica collezione deriva da un mio credo: le persone hanno due spinte contrapposte al loro interno, una verso una dimensione eterna dove le cose durano nel tempo; l’altra verso il cambiamento. Nel mio design oscillo e mi muovo tra questi due poli, l’antico e il nuovo, la rassicurazione e l’innovazione. Credo che sia una risposta ad un sentimento molto umano. The Wanders Collection riflette appunto questo dualismo.”

“The original concept for the collection came from a fantasy I had of taking a bath in a bar of soap. The ultimate clean! This idea I held for a long time, before Bisazza helped me realize it. The collection then grew to consist of three components, each with a different aesthetic ranging from new antiques to constructive architecture.

This idea to present multiple eras in a single collection comes from my belief that people have two forces inside them: one imagines an eternity where they want things to last and the other edges towards change. I move between these ideas of ancient and new, comfort and novelty. I believe it is very human to do so and so the collection reflects this mentality.”

Marcel Wanders





Vasca / bathtub **Soaptub**
Miscelatore per bordo vasca / deck mounted bath mixer **Petal 24 Red**
Console **New Antiques Table 127 Black**
Lavabo / washbasin **Soapsink 55**
Miscelatore da lavabo / mixer for washbasin **Petal 20 Red**
Specchio / mirror **New Antiques Mirror Black**



Console **New Antiques Table 180 Black**
Lavabo / washbasin **Soapsink 92**
Miscelatore / mixer **Petal 34 Chrome**
Specchio / mirror **New Antiques Mirror Black**



Console **New Antiques Table 165 Black**
Lavabo / washbasin **Soapsink 55**
Miscelatore / mixer **Petal 34 Chrome**
Mobile contenitore / cabinet **Architectural Cabinet 200 Black**



Console **New Antiques Table 180 Black**
Lavabo / washbasin **Soapsink 55**
Miscelatore / mixer **Petal 20 Red**
Specchio / mirror **Architectural Mirror 200 Black**





Sopra / above
Miscelatore / mixer **Petal 20 Red**



Destra / right
Lavabo / washbasin **Soapsink 92**
Miscelatore / mixer **Petal 34 Red**



Lavabo / washbasin **Soapsink 35**
Miscelatore / mixer **Petal 21 Red**
Specchio / mirror **New Antiques Mirror White**



Console **New Antiques Table 180 White**
Lavabo / washbasin **Soapsink 92**
Miscelatore / mixer **Petal 20 Red**
Specchio / mirror **New Antiques Mirror White**



Cassettiera / drawer unit **Quadro Vanity Bloem**
Lavabo / washbasin **Soapsink 55**
Miscelatore / mixer **Petal 34 Red**
Specchio / mirror **Architectural Mirror 70 Glossy White**



Lavabo / washbasin **Soapsink 55**
Miscelatore / mixer **Petal 20 Red**
Mobile contenitore / cabinet **Architectural Cabinet 70 Black**



Mobile contenitore / cabinet **Architectural Cabinet 200 Black**

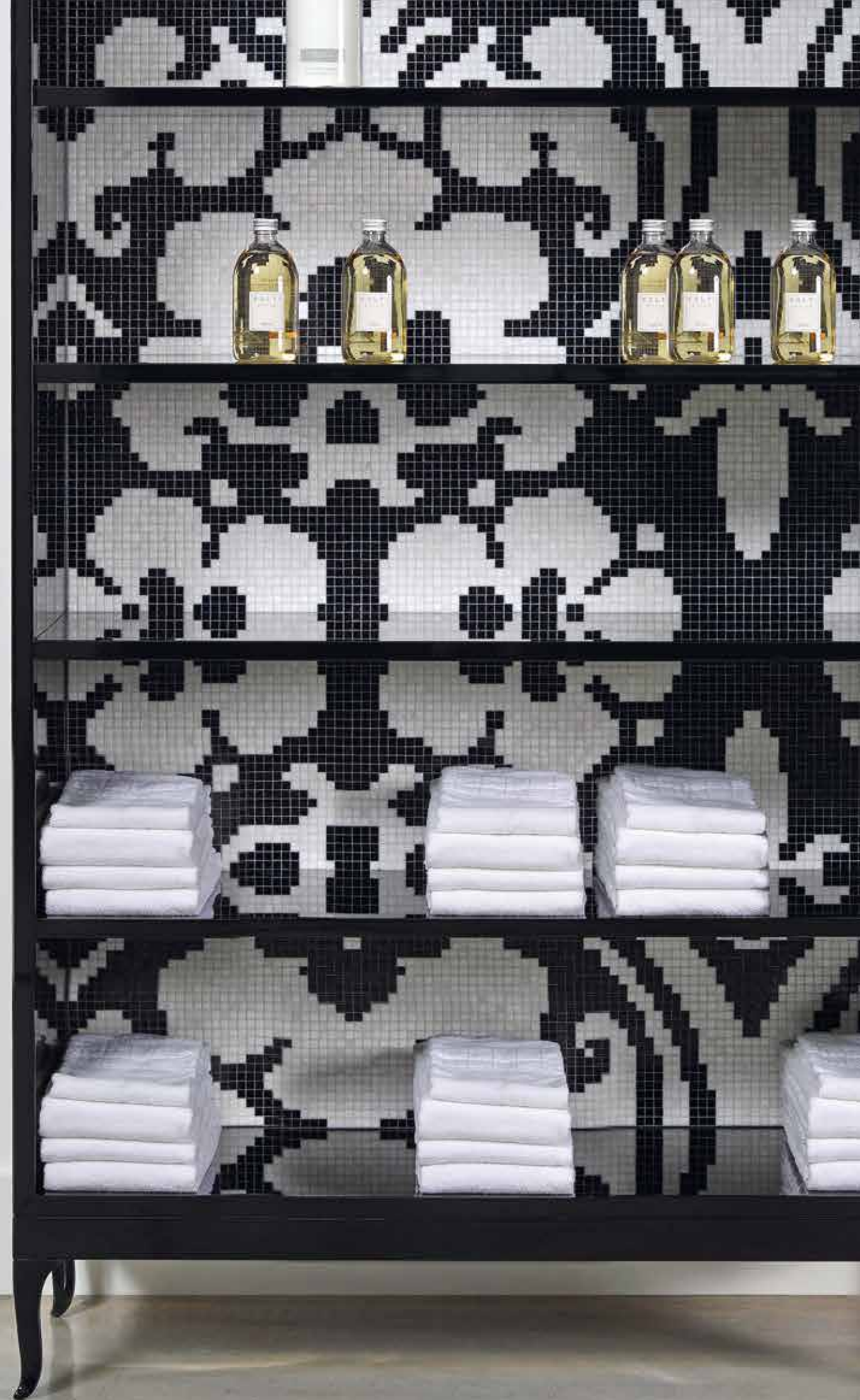



Vasca / bathtub **Soaptub**
Miselatore / mixer **Petal 24 Red**



Vasca / bathtub **Soaptub**
Miscelatore / mixer **Petal 24 Red**



Lampadario-doccia / chandelier-shower **Crystal Shower**

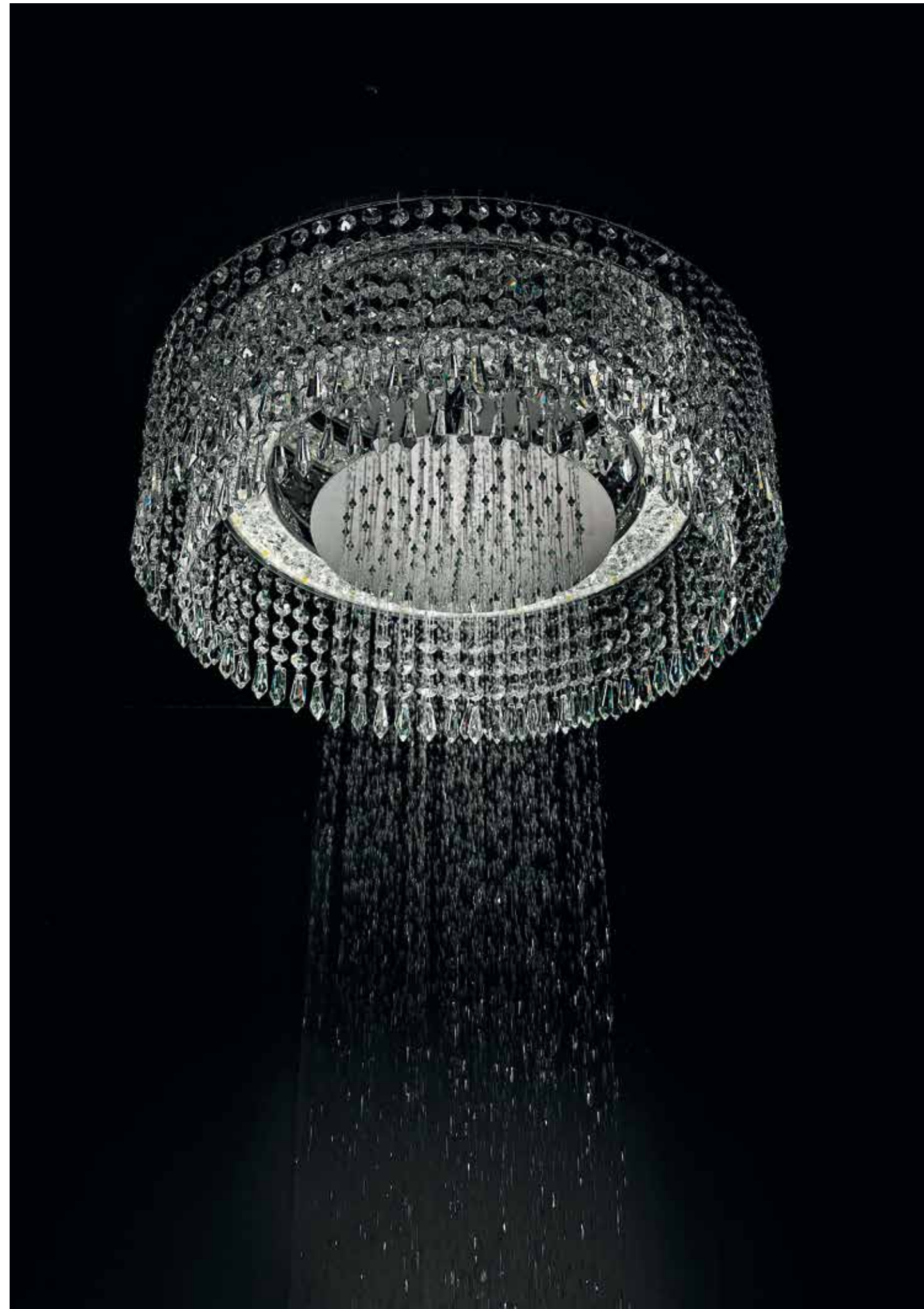



THE NENDO COLLECTION

design Nendo

"Il nostro obiettivo per questa collezione bagno era quello di creare un'impressione unica e originale, assemblando i diversi elementi, come se fossero "tutti insieme nella stessa vasca". La sensazione di condividere il momento del bagno con qualcuno che non conosci, in un locale termale o in un bagno pubblico, è un'usanza importante tipica della cultura giapponese. La nostra collezione bagno per Bisazza vuole esprimere proprio questo concetto.

Il nostro intento è infatti, da una parte, quello di poter mettere insieme elementi diversi, raccogliendoli in un unico contenitore e, dall'altra, quello di creare oggetti diversi moltiplicando lo stesso elemento. I rubinetti sono inseriti all'interno del lavabo e della vasca da bagno, immersi nell'acqua vicino agli accessori. Un vassoio posto all'interno del lavabo diventa un'isola pensata per gli oggetti che devono rimanere asciutti. Nella console, il lavandino è inserito in una cornice di legno, attraversata dal tubo dell'acqua che, alzandosi dal pavimento, diventa rubinetto..."

"Our objective for this bathroom collection was to create a strong singular impression by assembling the various elements of a bathroom suite as though they were 'all in the bath together'. The feeling of connection that comes from a bath with someone you don't know at a hot spring or local public bath is an important part of Japanese culture. Our bathroom collection for Bisazza expresses this feeling through its design.

The two key parts of the strategy are details that present the different elements as though they have been stored together in a box, and elements that go together well when used in multiples.

The taps are located inside the washbasin and bathtub, submerged in water alongside accessories. A tray placed inside the basin becomes an island for objects that need to be kept dry. The washbasin stand encloses the washbasin inside a wood frame, through which the water pipe rises up from the floor, turning into the tap..."

Nendo

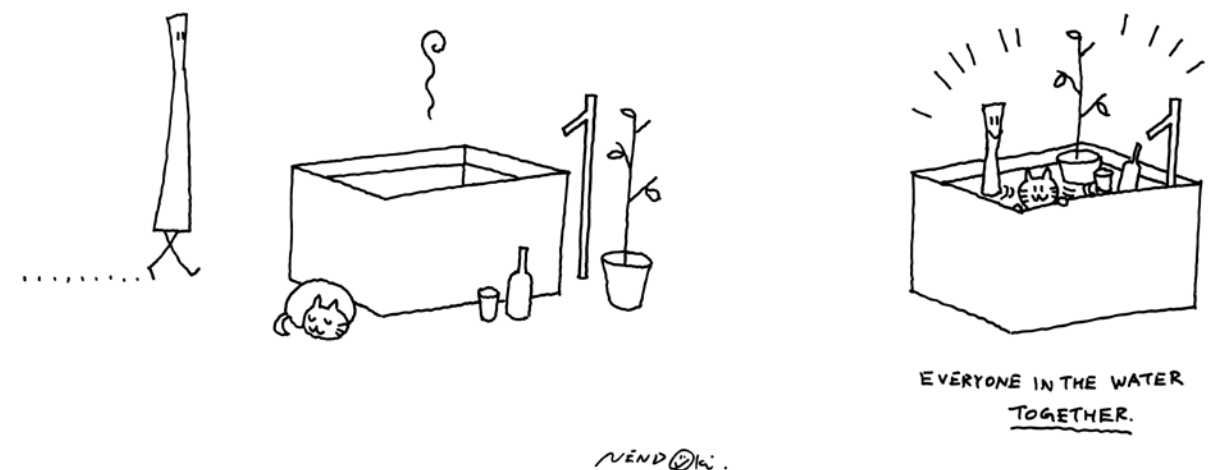



Vasca / bathtub **Ofuro**
Miscelatore interno vasca / internal bathtub mixer **Mizu 35**



Lavabo / washbasin **Shiro 60 Cabinet**
Miscelatore da lavabo / washbasin mixer **Mizu 33**
Mobile contenitore / cabinet **Tansu**
Specchio / mirror **Hagami 40**
Mensole / shelves **Tana 42, Tana 65**



Vasca / bathtub **Ofuro**
Miscelatore interno vasca / internal bathtub mixer **Mizu 35**
Portasalviette / towel hanger **Rasen**



Sopra / above
Vasca / bathtub **Ofuro**
Miscelatore free-standing esterno vasca / free-standing external bathtub mixer **Mizu 30**

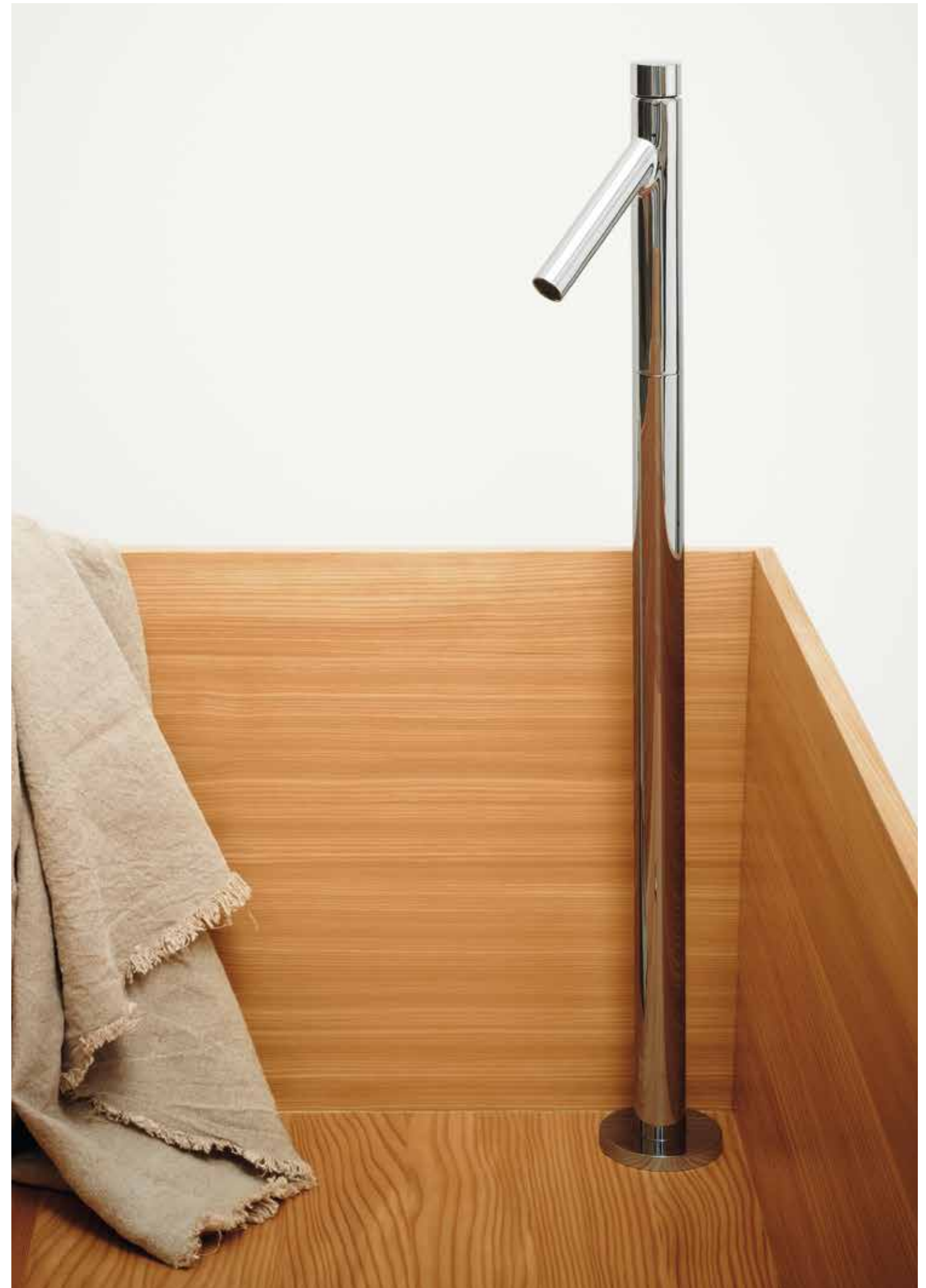

Destra / right
Vasca / bathtub **Ofuro**
Miscelatore interno vasca / internal bathtub mixer **Mizu 35**



Lavabo / washbasin **Kiwaku**
Miscelatore / mixer **Mizu 30**
Cassettiera / drawer unit **Nidan**
Specchio / mirror **Hagami 40**
Lampada / lamp **Komori 1**
Sgabello / stool **Isu**



Mobile contenitore / cabinet **Totu 3**



Lavabo / washbasin **Moku 60**
Miscelatore / mixer **Mizu 33**
Specchio / mirror **Hagami 40**



Lavabo / washbasin **Kiwaku**
Miscelatore / mixer **Mizu 30**
Lampada / lamp **Komori 1**
Specchio / mirror **Hagami 40**



Lavabo / washbasin **Moku 60**
Miscelatore / mixer **Mizu 33**
Specchio / mirror **Hagami 40**
Portasalviette / towel hanger **Maghe 42, Maghe 65**
Sgabello / stool **Isu**



Lavabo / washbasin **Shiro 60**
Miscelatore / mixer **Mizu 33**
Mensola porta-lavabo / Washbasin shelf **Dai**
Specchio / mirror **Hagami 56**



Lavabo / washbasin **Moku 120** Floor cabinet
Miscelatore / mixer **Mizu 29**
Specchio / mirror **Hagami 40**



Mobile contenitore / cabinet **Totu 6**



Mobile contenitore / cabinet **Tansu**



Mobile contenitore / cabinet **Totu 3**
Orologio / clock **Tokei Duo**



Schede Tecniche
Technical Specifications

Lavabi
Washbasins

Amaryllis

Lavabo in ceramica
Ceramic washbasin



Amaryllis Black Amaryllis White Amaryllis Gold * Amaryllis Platinum *

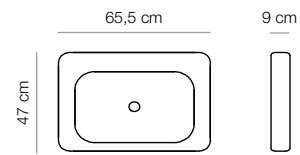

Azalea

Lavabo in ceramica con specchio ingranditore (2x)
Ceramic washbasin with magnifying mirror (2x)



Azalea Black Azalea White Azalea Gold * Azalea Platinum *

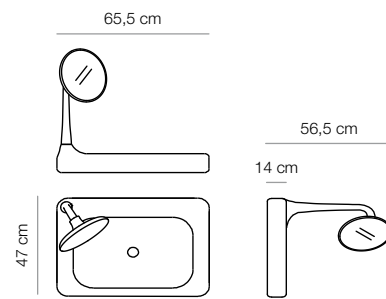

Anemone

Lavabo in ceramica con lampada
Ceramic washbasin with lamp



Anemone Black Anemone White Anemone Gold * Anemone Platinum *

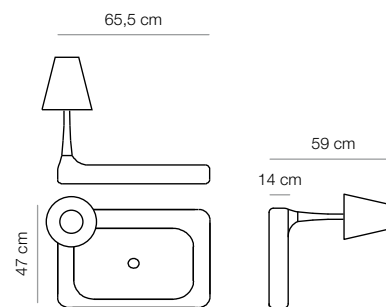

Bergamot

Lavabo ottagonale in ceramica
Ceramic octagonal washbasin



Bergamot Black Bergamot White

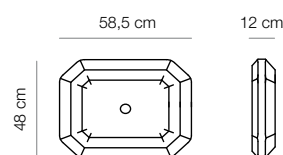

Console
Tables

Cyclamen

Console piccola
Small table



Cyclamen 65 Black Cyclamen 65 White Cyclamen 65 Grey

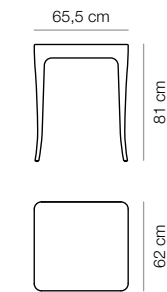

Console grande
Large table



Cyclamen 140 Black Cyclamen 140 White Cyclamen 140 Grey

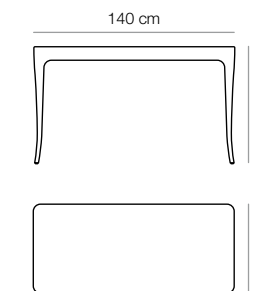

Asphodel

Console con top in marmo Nero Marquinia o Bianco Carrara
Table with top in Nero Marquinia or Bianco Carrara marble

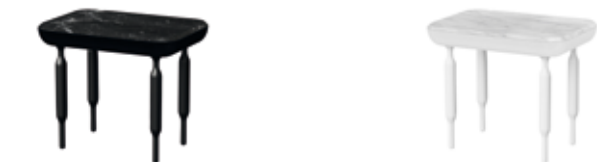

Asphodel 80 Black Asphodel 80 White

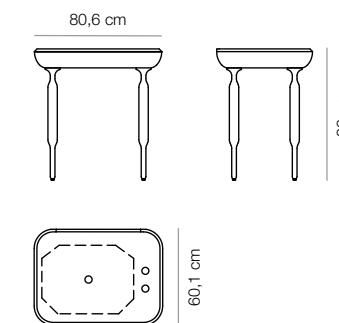

Asphodel 155 Black Asphodel 155 White

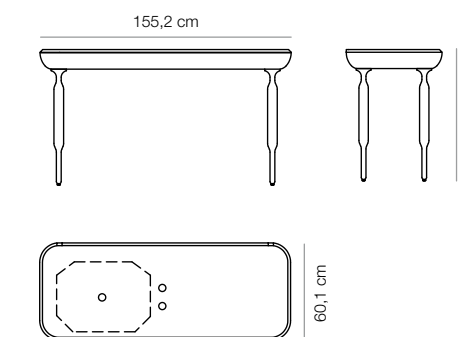

* Per il carattere artigianale della lavorazione, la superficie in platino e oro potrebbe risultare non perfettamente uniforme e regolare.
The platinum or gold coated surface is handcrafted and might not appear perfectly uniform and consistent.

Per tutti i dettagli sulle versioni disponibili, vi invitiamo a consultare il listino prezzi. For details on the available versions, please refer to the price list.

Console
Tables

Columbine

Console con struttura in alluminio cromato e top in marmo Nero Marquinia o Bianco Carrara
Table with chrome aluminium structure and top in Nero Marquinia or Bianco Carrara marble



Columbine 80 Black



Columbine 80 White

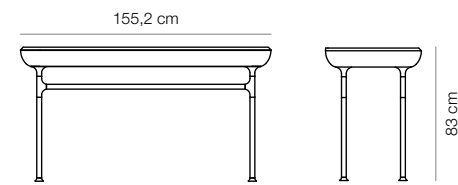
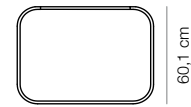
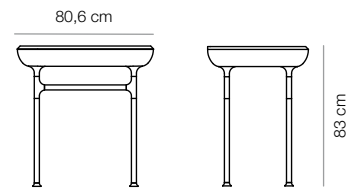

Columbine 155 Black



Columbine 155 White

Crocus

Console con struttura in alluminio ramato e top in marmo Nero Marquinia o Bianco Carrara
Table with copper aluminium structure and top in Nero Marquinia or Bianco Carrara marble



Crocus 80 Black



Crocus 80 White

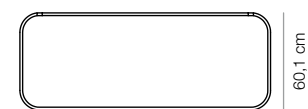
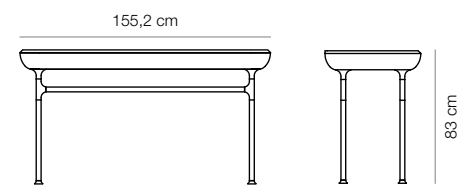
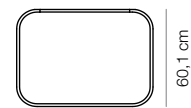
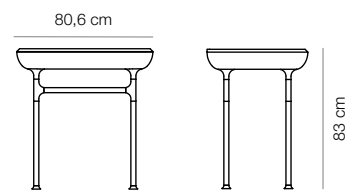

Crocus 155 Black



Crocus 155 White

Top Lavabo
Vanity Tops

Daisy

Top lavabo con piano in marmo Nero Marquinia o Bianco Carrara
Vanity top with Nero Marquinia or Bianco Carrara marble



Daisy 80 Black



Daisy 80 White

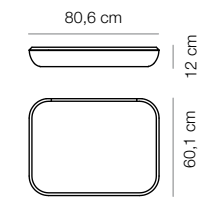

Daisy 155 Black



Daisy 155 White

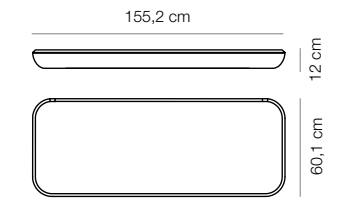

Amaranth

Cassettiera sospesa, con piano in marmo Nero Marquinia o Bianco Carrara
Hanging drawer unit with top in Nero Marquinia or Bianco Carrara marble



Amaranth Black



Amaranth White

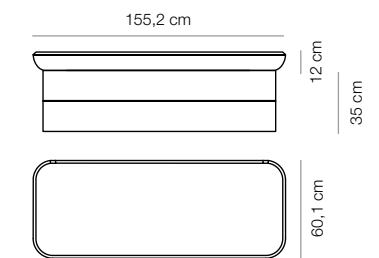

Cassettiera
Drawer unit

Buttercup

Cassettiera a due cassetti in legno laccato con piano in marmo Nero Marquinia o Bianco Carrara
2-drawers lacquered wooden drawer unit with top in Nero Marquinia or Bianco Carrara marble



Buttercup Black



Buttercup White

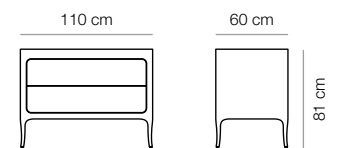

Mobili Contenitore
Cabinets

Hyacinth

Mobile contenitore a vetri
Glass cabinet



Hyacinth 60 Black Hyacinth 60 White

Hyacinth 120 Black Hyacinth 120 White

Heliotrope

Mobile contenitore
Cabinet

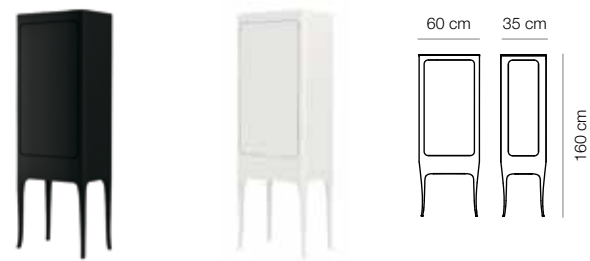

Heliotrope Black Heliotrope White

Accessori
Accessories

Sunflower

Mensola in marmo Nero Marquinia o Bianco Carrara
Shelf in Nero Marquinia or Bianco Carrara marble



Sunflower Black

Sunflower White

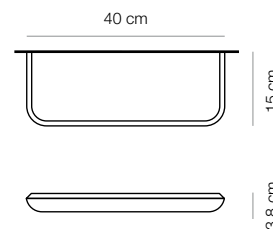

Accessori
Accessories

Primrose

Appendiabiti in ceramica
Ceramic hanger



Primrose Black



Primrose White



Primrose Gold



Primrose Platinum

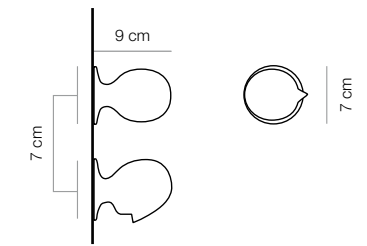

Vasche
Bathtubs

Daffodil

Vasca in metacrilato con telaio esterno in legno verniciato lucido
Bathtub in metacrylic with high gloss varnished wooden frame



Daffodil 205 Black



Daffodil 205 White

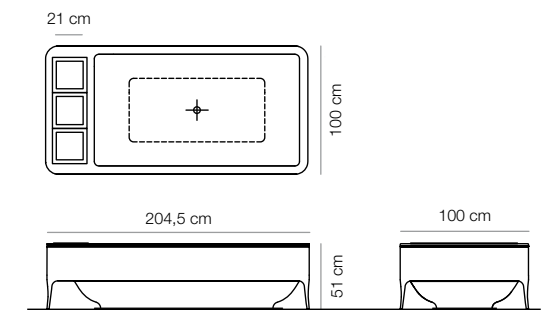

Daffodil 175 Black



Daffodil 175 White



Daffodil 175 Grey

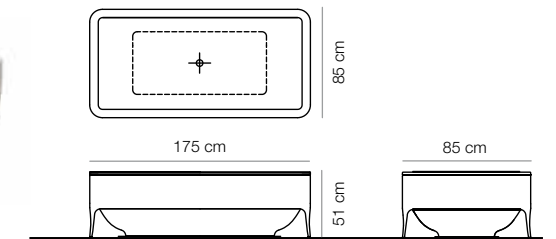

Accessori vasca
Bathtub accessories

Cornflower

Coperchio contenitori vasca Daffodil 205 in marmo Nero Marquinia o Bianco Carrara
Containers' lid for Daffodil 205 bathtub in Nero Marquinia or Bianco Carrara marble



Cornflower Black



Cornflower White

Specchi
Mirrors

Dandelion

Specchio rettangolare con bordi arrotondati
Rectangular mirror with rounded corners



Dandelion 44 Black



Dandelion 44 White

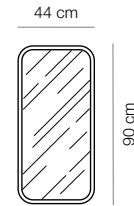

Dandelion 128 Black



Dandelion 128 White

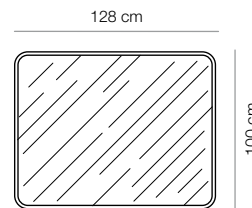

Lilac

Specchio in acciaio inox
Stainless steel mirror



Lilac 180



Lilac 120



Lilac 90

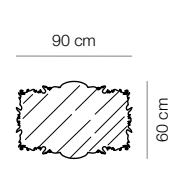
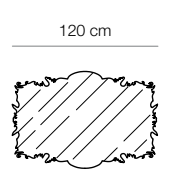
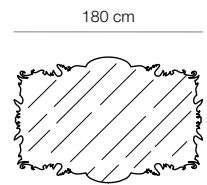

Helianthus

Specchio ingranditore (2x) in ceramica
Ceramic magnifying mirror (2x)



Helianthus Black



Helianthus White



Helianthus Gold *



Helianthus Platinum *

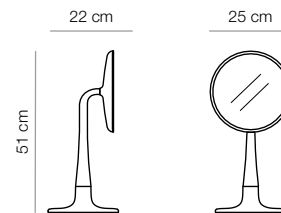

Lampade
Lamps

Petunia

Lampada in ceramica per console
Ceramic lamp for table



Petunia Black



Petunia White



Petunia Gold *



Petunia Platinum *

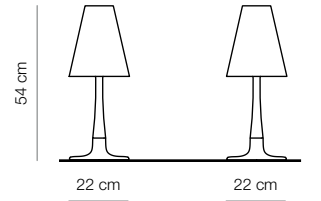

Tansy

Lampada in ceramica da parete
Wall-mounted ceramic lamp



Tansy Black



Tansy White



Tansy Gold *



Tansy Platinum *

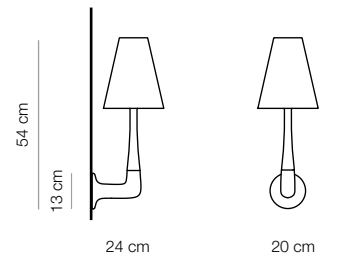

Piatti doccia
Shower trays

Waterlily

Piatto doccia in marmo Nero Marquina o Bianco Carrara
Shower tray in Nero Marquina or Bianco Carrara marble



Waterlily 120 Black



Waterlily 120 White

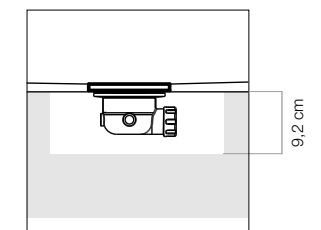
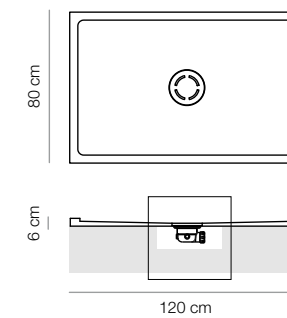

Waterlily 160 Black



Waterlily 160 White

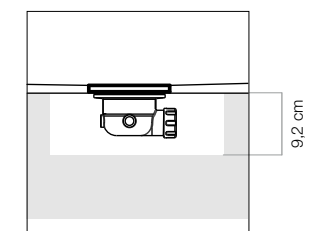
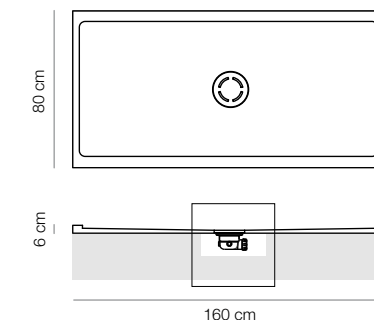

* Per il carattere artigianale della lavorazione, la superficie in platino e oro potrebbe risultare non perfettamente uniforme e regolare.
The platinum or gold coated surface is handcrafted and might not appear perfectly uniform and consistent.

Docce
Showers

Tuberose

Parete doccia in vetro serigrafato
Silk-screen glass shower wall



Tuberose 80 Black Tuberose 100 Black Tuberose 120 Black



Tuberose 80 White Tuberose 100 White Tuberose 120 White

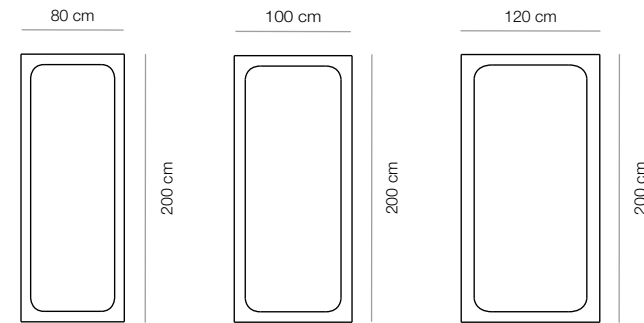

Mimosa

Lastra in marmo Nero Marquinia o Bianco Carrara
Slab in Nero Marquinia or Bianco Carrara marble



Mimosa 60 Black Mimosa 80 Black Mimosa 82 Black



Mimosa 60 White Mimosa 80 White Mimosa 82 White

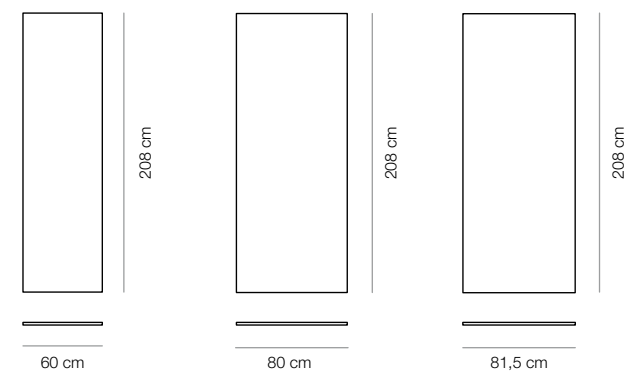

Docce
Showers

Tutte le pareti sono reversibili (installazione in angolo sinistro o destro) e dotate di profilo a pavimento. Profili a muro per la compensazione dei "fuori squadra" e barra di stabilizzazione in alluminio devono essere aggiunti in fase di ordine (vedi listino prezzi).
All shower screens are reversible (installation left or right corner), equipped with floor profile. Wall profiles for the adjustment of any unevenness in the walls and aluminium stabilization bar must be ordered separately (please, refer to the price list).

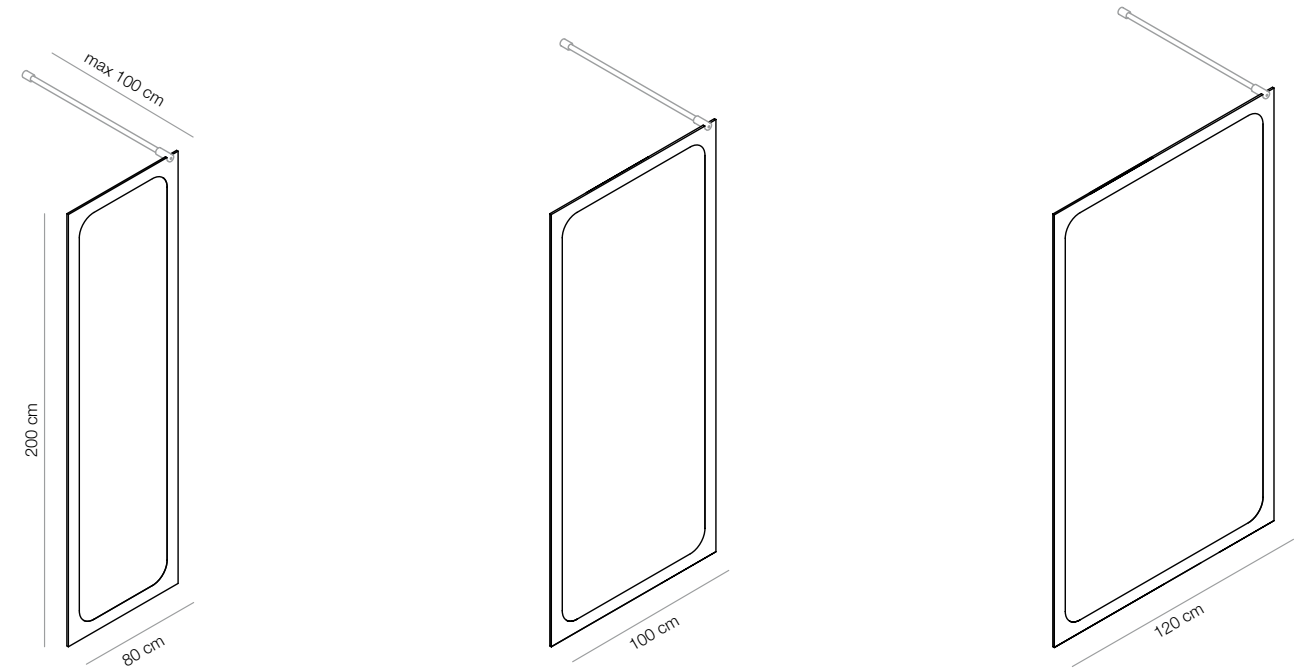

Montaggio in angolo / Corner installation

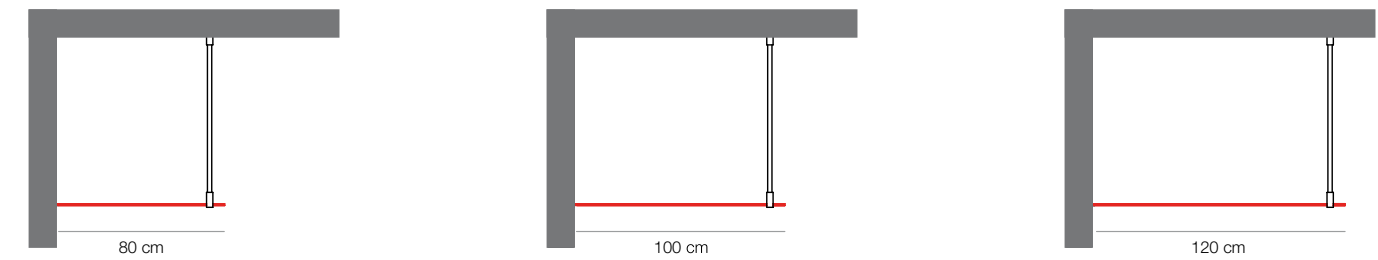

Montaggio in nicchia / In niche installation

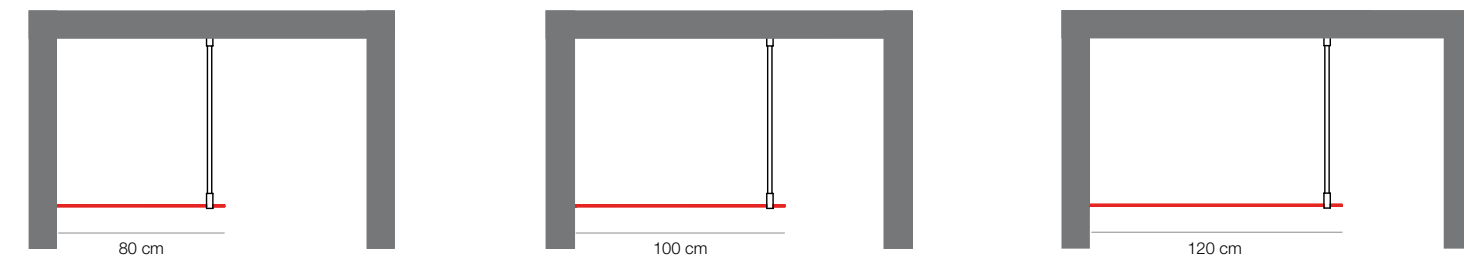

Parete doccia libera / Free standing shower screen



Rubinetteria

Taps

Freesia

Miscelatore monocomando da lavabo
Single-lever basin mixer



Freesia 35

Miscelatore monocomando da bidet
Single-lever bidet mixer



Freesia 37

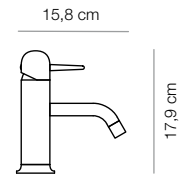

15,8 cm

17,9 cm

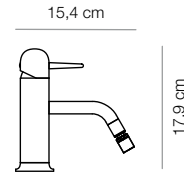

15,4 cm

17,9 cm

Miscelatore monocomando da lavabo a parete
Single-lever basin mixer



Freesia 36

Miscelatore monocomando da vasca a parete
Floor standing single-lever bath and shower mixer



Freesia 39

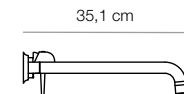

35,1 cm

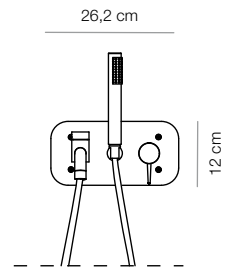

26,2 cm

12 cm

Miscelatore termostatico monocomando doccia ad incasso con flessibile (150 cm) e soffione fissato a parete
Single-lever thermostatic shower mixer with hose (150 cm) and wall-mounted shower head



Freesia 77

Miscelatore monocomando vasca a pavimento
Floor standing single-lever bath and shower mixer



Freesia 38

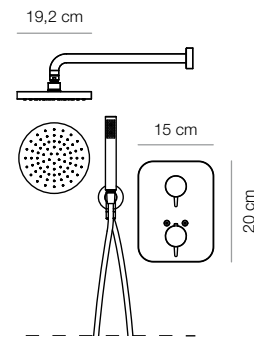

19,2 cm

15 cm

20 cm

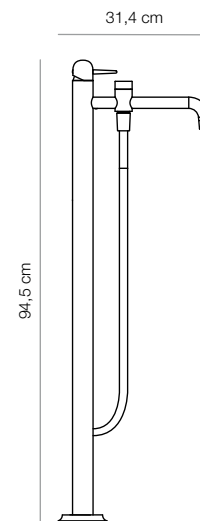

31,4 cm

94,5 cm

Gentian

Miscelatore monocomando da lavabo a due fori cromato o ramato
Two-hole single-lever basin mixer



Gentian 75 Chrome



Gentian 75 Copper

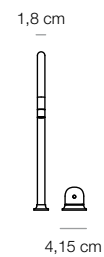

1,8 cm

4,15 cm

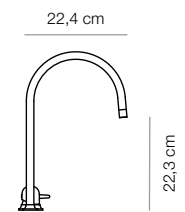

22,4 cm

22,3 cm

Lavabi
Washbasins

Soapsink

Lavabo in ceramica smaltata
Glazed ceramic washbasin



Soapsink 55

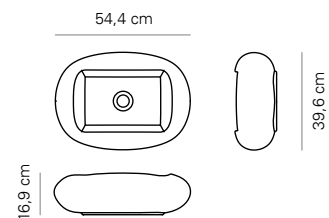

Soapsink 92

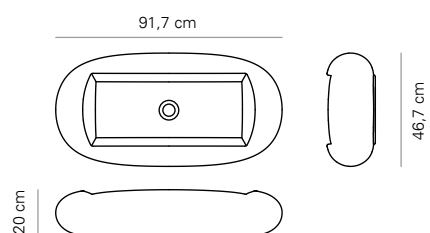

Lavabo sospeso da parete in ceramica smaltata
Wall-hung glazed ceramic washbasin



Soapsink 35

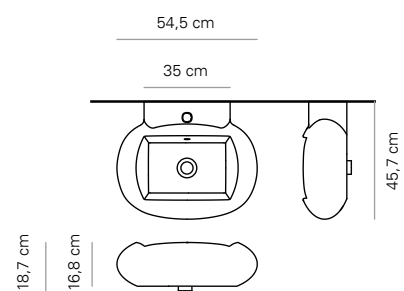

Console
Tables

New Antiques Table

Console in resina con struttura in legno laccato opaco e piano in vetro
Resin table with matte lacquered wooden structure and glass top



New Antiques Table 127 Black



New Antiques Table 127 White

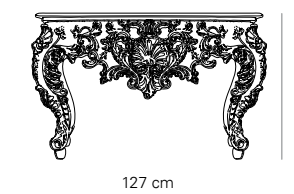

New Antiques Table 180 Black



New Antiques Table 180 White

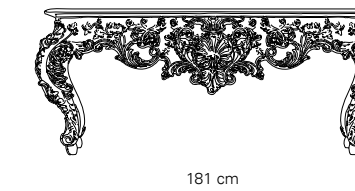

Console grande free-standing laccata opaco con top in vetro
Large free-standing matte lacquered table with glass top



New Antiques Table 165 Black



New Antiques Table 165 White

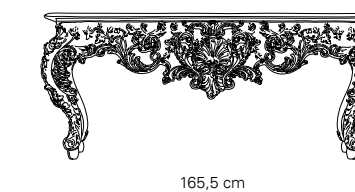

Specchi
Mirrors

New Antiques Mirror

Specchio in resina con telaio in legno laccato opaco
Resin mirror with matte lacquered wooden frame



New Antiques Mirror Black



New Antiques Mirror White

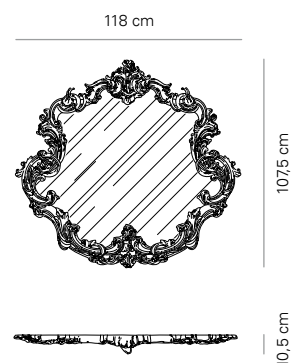

Architectural Mirror

Specchio rettangolare con cornice in legno laccato opaco
Rectangular mirror with matte lacquered wooden frame



Architectural Mirror 200 Black



Architectural Mirror 200 White

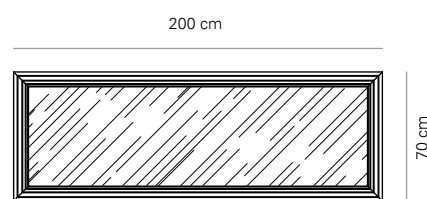

Architectural Mirror 70 Black



Architectural Mirror 70 White

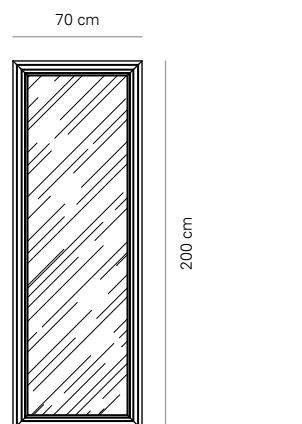

Architectural Mirror 70 Glossy White

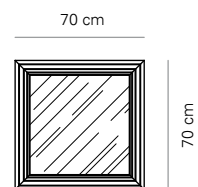

Specchio quadrato con cornice in legno laccato opaco o lucido
Square mirror with matte or glossy lacquered wooden frame



Mobili Contenitore
Cabinets

Architectural Cabinet

Mobile contenitore in legno laccato opaco con anta a specchio
Matte lacquered wooden cabinet with mirror door



Architectural Cabinet 200 Black



Architectural Cabinet 200 White

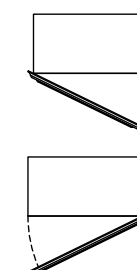
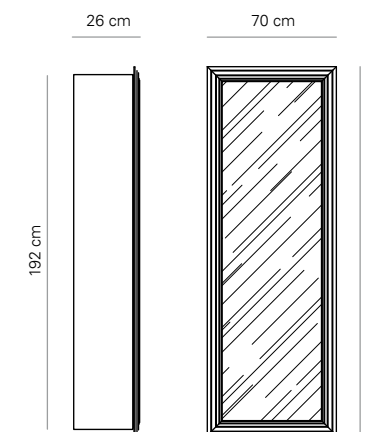

Architectural Cabinet 70 Black



Architectural Cabinet 70 White

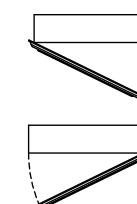
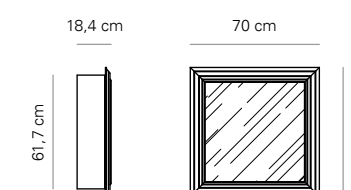

Cassettiera con inserti in mosaico di vetro
Drawer unit with glass mosaic

Quadro Vanity

Cassettiera in mdf/hdf laccato lucido con inserti in mosaico di vetro* (Bloem rosso). Foro per lavabo Soapskin 55
Polished lacquered mdf/hdf drawer unit with glass mosaic (Bloem rosso). Hole for washbasin Soapskin 55*



Quadro Vanity Bloem

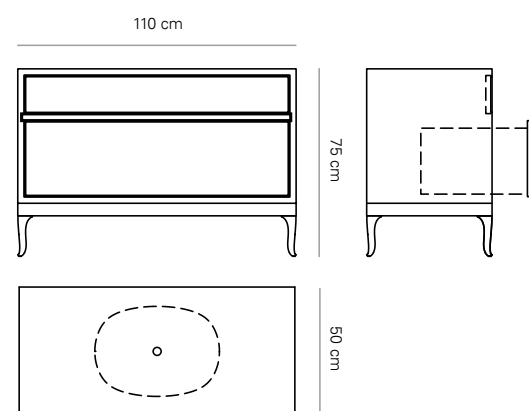

Quadro Commode

Cassettiera in mdf/hdf laccato lucido con inserti in mosaico di vetro* (Bloem rosso)
Polished lacquered mdf/hdf drawer unit with glass mosaic (Bloem rosso)*



Quadro Commode Bloem

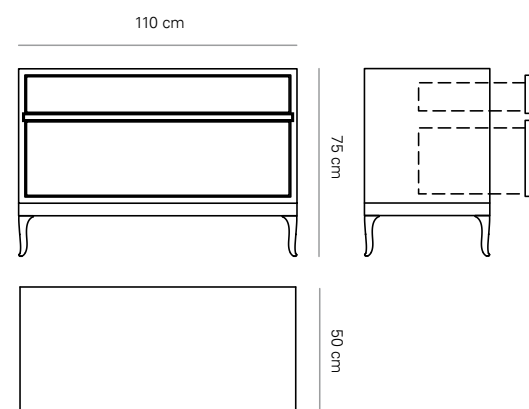

Mobile contenitore con inserti in mosaico di vetro
Cabinet with glass mosaic

Quadro Cabinet

Mobile contenitore a giorno in mdf/hdf laccato lucido con inserti in mosaico di vetro* (Decoupage noir)
Polished lacquered mdf/hdf open cabinet with glass mosaic (Decoupage noir)*



Quadro Cabinet Decoupage

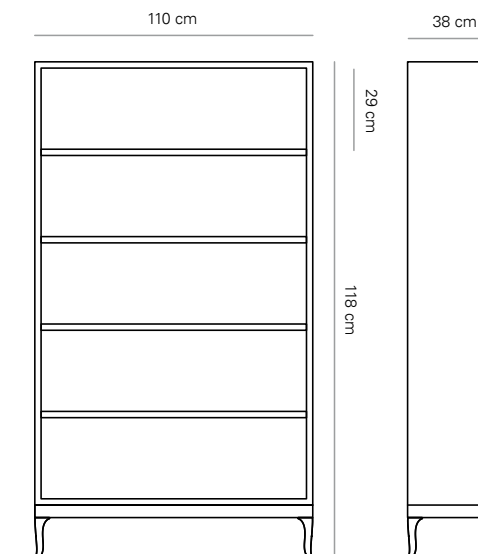

Vasca
Bathtub

Soaptub

Vasca in vetroresina
Fiberglass bathtub



Soaptub

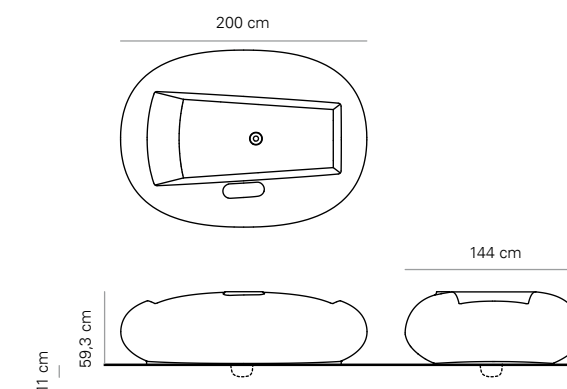

* Edizione limitata n. 12 pezzi.
Numbered limited edition 12 pieces.

Per tutti i dettagli sulle versioni disponibili, vi invitiamo a consultare il listino prezzi. *For details on the available versions, please refer to the price list.*

Accessori
Accessories

Tile

Gancio appendiabiti
Clothes hanger



Tile Red



Tile Chrome

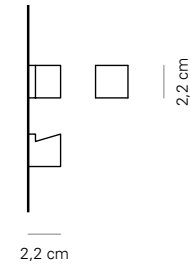

Flower

Appendiabiti fiore
Flower clothes hanger



Flower Red



Flower Chrome

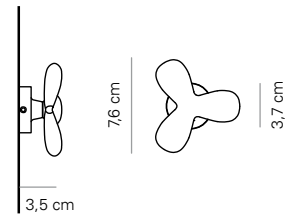

Towel Rail

Portasalviette cromato
Chrome-plated towel rail



Towel Rail

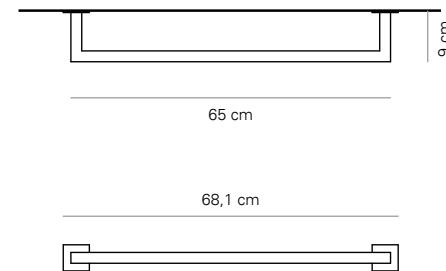

Rubinetteria
Taps

Petal

Miscelatore monocomando da lavabo a parete a due fori con leva rossa
Wall-mounted single lever two hole basin mixer with red lever



Petal 20 Red

Miscelatore monocomando da lavabo a parete a due fori con leva cromata
Wall-mounted single lever two hole basin mixer with chrome-plated lever



Petal 20 Chrome

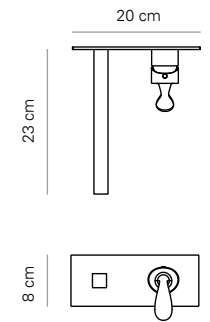

Miscelatore monocomando da console a due fori con leva rossa
Table-mounted single lever two hole mixer with red lever



Petal 34 Red

Miscelatore monocomando da console a due fori con leva cromata
Table-mounted single lever two hole mixer with chrome-plated lever



Petal 34 Chrome

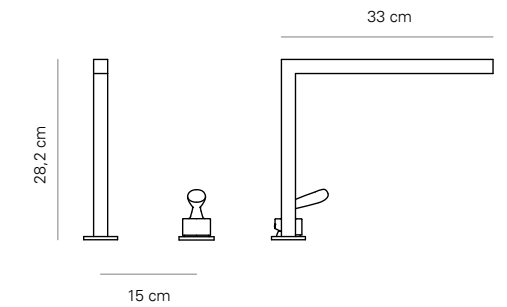

Miscelatore monocomando da lavabo con leva rossa
Single lever washbasin mixer with red lever



Petal 21 Red

Miscelatore monocomando da lavabo con leva cromata
Single lever washbasin mixer with chrome-plated lever



Petal 21 Chrome

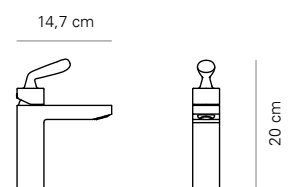

Miscelatore monocomando da bidet con leva rossa
Single lever bidet mixer with red lever



Petal 23 Red

Miscelatore monocomando da bidet con leva cromata
Single lever bidet mixer with chrome-plated lever



Petal 23 Chrome

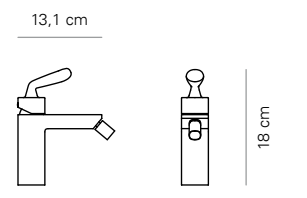

Rubinetteria Vasca Bathtub Taps

Petal

Miscelatore monocomando per bordo vasca con leve rosse, doccetta e deviatore
Deck mounted bath mixer with red levers, hand shower and diverter



Petal 24 Red

Miscelatore monocomando per bordo vasca con leve cromate, doccetta e deviatore
Deck mounted bath mixer with chrome-plated levers, hand shower and diverter



Petal 24 Chrome

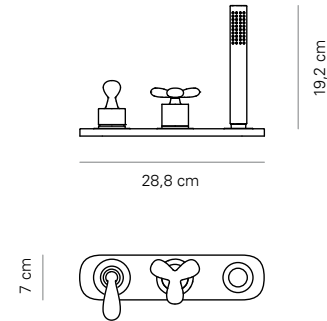

Miscelatore monocomando a incasso per vasca con leve rosse, bocca di erogazione, doccetta e deviatore
Wall-mounted bath mixer with red levers, spout, hand shower and diverter



Petal 25 Red

Miscelatore monocomando a incasso per vasca con leve cromate, bocca di erogazione, doccetta e deviatore
Wall-mounted bath mixer with chrome-plated levers, spout, hand shower and diverter



Petal 25 Chrome

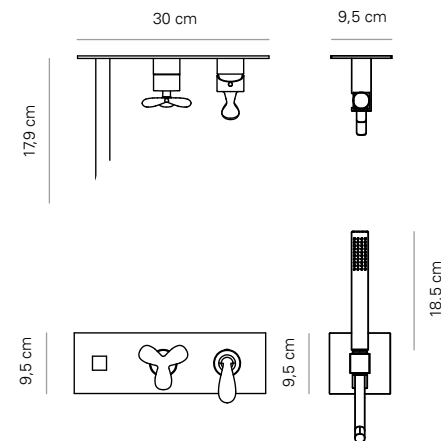

Gruppo termostatico per doccia con leve rosse e doccetta
Thermostatic shower group with red levers and hand shower



Petal 26 Red

Gruppo termostatico per doccia con leve cromate e doccetta
Thermostatic shower group with chrome-plated levers and hand shower



Petal 26 Chrome

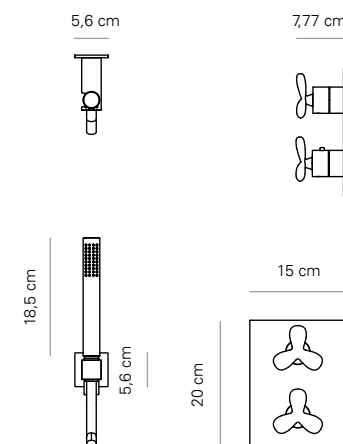

Rubinetteria Doccia Shower Taps

Petal

Soffione doccia anti-calcare da parete
Wall-mounted anti-lime shower head



Petal 35

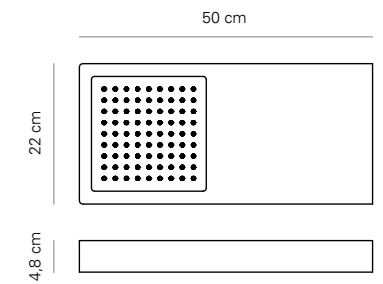

Crystal Shower

Lampadario-doccia grande in acciaio inox e cristalli, con illuminazione monocolora bianca a LED
Large chandelier-shower in stainless steel and crystal glass with white single colour LED lighting

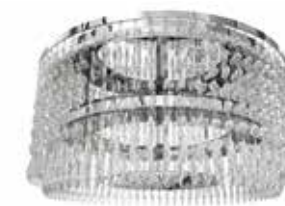

Crystal Shower

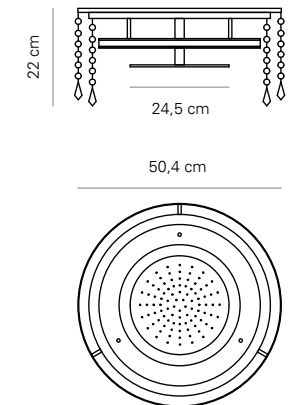

THE NENDO COLLECTION

Lavabi in Legno
Wood Washbasins

Moku

Lavabo sospeso in legno di larice
Wall-mounted washbasin in solid larch wood



Moku 60

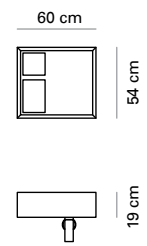

Lavabo in legno di larice integrato al mobile contenitore sospeso ad un'anta
Single door wall-mounted washbasin cabinet in larch wood



Moku 60 Cabinet

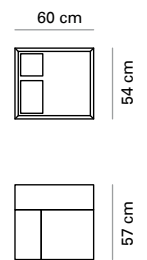

Lavabo in legno di larice integrato al mobile contenitore da terra a 3 ante
Three door washbasin floor cabinet in larch wood



Moku 120 Floor cabinet

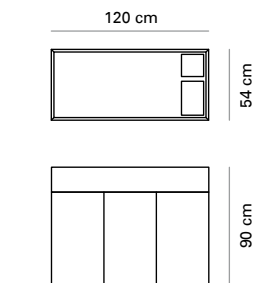

Lavabo in legno di larice integrato al mobile contenitore sospeso a 2 ante
Two door wall-mounted washbasin cabinet in larch wood



Moku 120 Cabinet

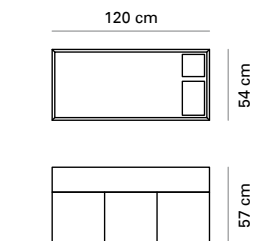

Lavabi
Washbasins

Shiro

Lavabo sospeso in mineralmarmo®
Wall-mounted washbasin in mineralmarmo®



Shiro 60

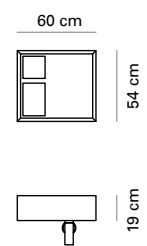

Lavabo sospeso in mineralmarmo® integrato al mobile contenitore ad un'anta in legno di larice
Wall-hung washbasin in mineralmarmo® built into one-door cabinet in larch wood



Shiro 60 Cabinet

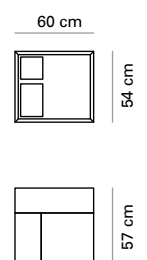

Mensola porta-lavabo
Washbasin shelf

Dai

Mensola porta-lavabo in legno di larice
Washbasin shelf in larch wood



Dai

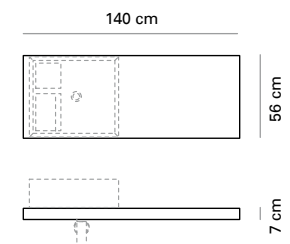

Lavabi Washbasins

Kiwaku

Top lavabo singolo in Cristalplant® con struttura in metallo verniciato rivestita in legno di larice
Single Cristalplant® washbasin. Counter with steel structure covered with larch wood



Kiwaku

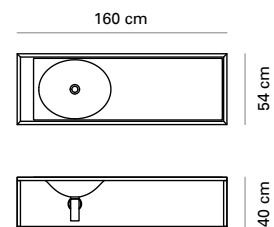

Top lavabo doppio in Cristalplant® con struttura in metallo verniciato rivestita in legno di larice
Double Cristalplant® washbasin. Counter with steel structure covered with larch wood



Kiwaku Duo

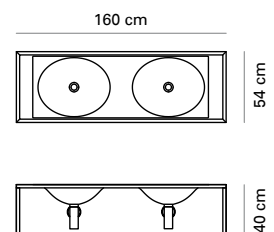

Mobili Contenitore Cabinets

Nidan

Cassettiera a 2 cassetti in legno di larice, per ripiano inferiore del lavabo Kiwaku
2-drawer larch wood drawer unit, suitable for Kiwaku



Nidan

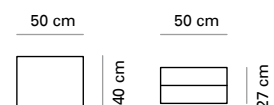

Tansu

Mobile contenitore sospeso in legno di larice
Wall-mounted cabinet in larch wood



Tansu

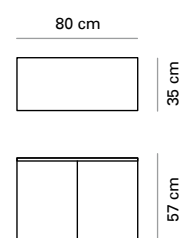

Mobili Contenitore Cabinets

Totu

Mobile contenitore con struttura in metallo verniciato bianco opaco e cassetti in legno di larice. Apertura a scorrimento laterale
Sliding drawer cabinet in larch wood. Steel structure with matte white varnish



Totu 3

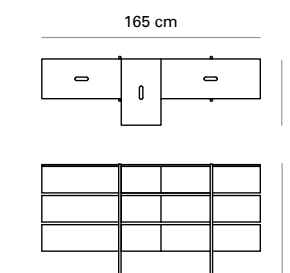

Totu 6

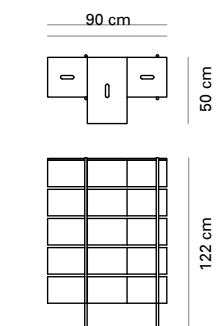

Vasca Bathtub

Ofuro

Vasca in legno di larice e contenitori porta-oggetti da fissare all'esterno
Bathtub and external storage boxes in larch wood



Ofuro

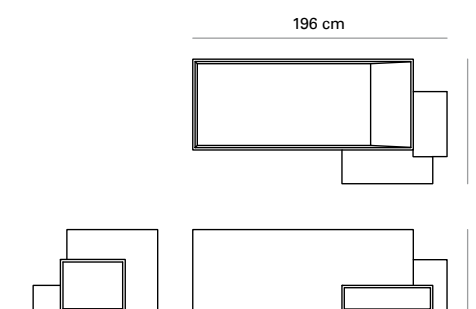

Specchi
Mirrors

Hagami

Specchio con cornice in legno di larice
Mirror with larch wood frame



Hagami 40

Hagami 56

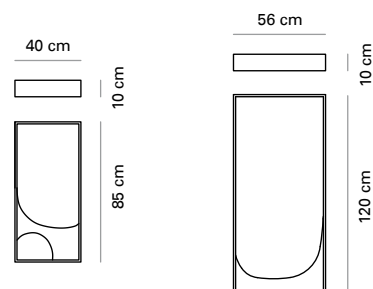

Accessori
Accessories

Isu

Sgabello in legno di larice
Stool in larch wood



Isu



Rasen

Portasalviette free-standing in metallo verniciato bianco
Free-standing towel hanger in matte white lacquered steel



Rasen

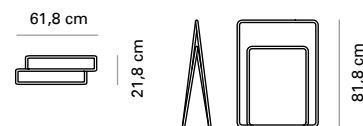

Accessori
Accessories

Maghe

Portasalviette da parete in metallo verniciato bianco
Wall-mounted towel hanger in matte white lacquered steel



Maghe 42



Maghe 65

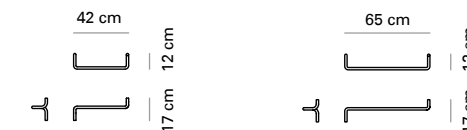

Tana

Mensola in metallo verniciato bianco con ripiano in legno di larice
Shelf in matte white lacquered steel and larch wood



Tana 42



Tana 65

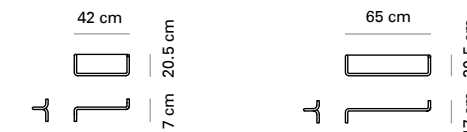

Tokei

Orologio da parete in resina laccata bianca
Clock with structure in matte white lacquered resin



Tokei



Tokei Duo

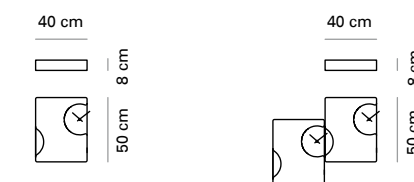

Rubinetti Taps

Mizu

Miscelatore monocomando cromato da lavabo
Chrome single-lever washbasin mixer



Mizu 33



Mizu 29

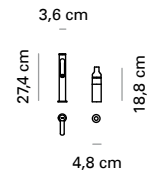
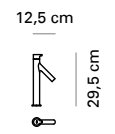

Miscelatore free-standing cromato per interno vasca Ofuro
Chrome free-standing internal mixer for bathtub Ofuro



Mizu 35

Miscelatore free-standing cromato per esterno vasca Ofuro e lavabi Kiwaku
Chrome free-standing external mixer for bathtub Ofuro and counters Kiwaku



Mizu 30

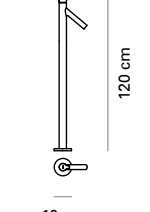
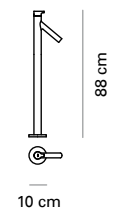

Miscelatore monocomando cromato da bidet, completo di scarico up&down
Chrome single-lever bidet mixer, with up&down waste



Mizu 32

Gruppo esterno termostatico doccia ad incasso con flessibile, doccetta e soffione da parete
Single-lever thermostatic shower mixer, hand shower, hose, wall-mounted shower head



Mizu 44

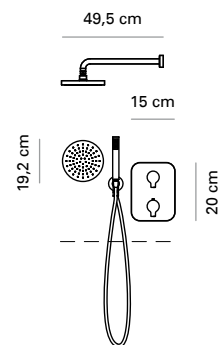
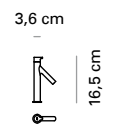

Illuminazione Lighting

Komori

Lampadario con struttura in ottone cromato e lampade in vetro soffiato verniciato cromo (IP20)
Chandelier with chrome brass structure and chrome lacquered blown glass (IP20)



Komori 3



Komori 6

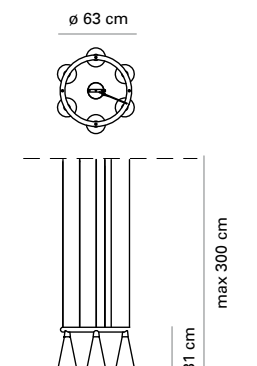
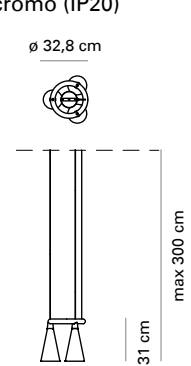

Komori 14



Komori 10

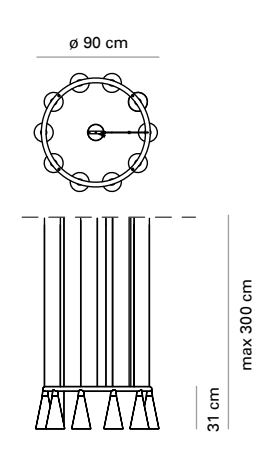
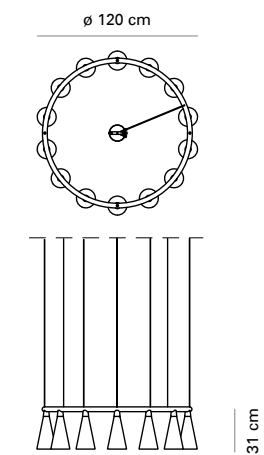

Komori 9



Komori 30

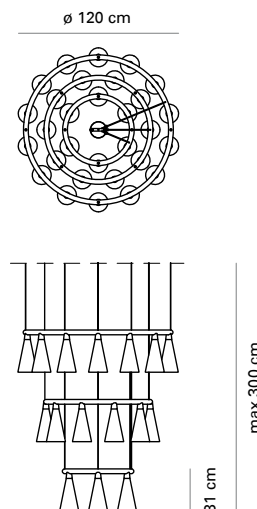
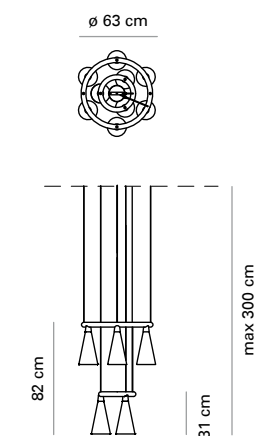

Lampada a sospensione in vetro soffiato verniciato cromo
Suspension lamp in chrome lacquered blown glass



Komori 1

Lampada a parete in vetro soffiato verniciato cromo
Suspension lamp in chrome lacquered blown glass



Komori 1 Kabe

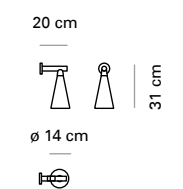
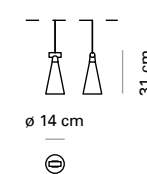

Manutenzione
Maintenance

THE HAYON COLLECTION

CONSOLE - TOP LACCATI - MOBILI CONTENITORI - MENSOLE

- Non usare in esterno

- Evitare l’esposizione diretta ai raggi solari per lungo tempo

- Evitare il contatto prolungato con lozioni, prodotti cosmetici o detergenti anche neutri concentrati che possono rovinare la laccatura.

Per la pulizia delle finiture laccate LUCIDE si può utilizzare un detergente liquido, neutro, non abrasivo, diluito in acqua tiepida, applicato con panno in microfibra. NON UTILIZZARE MAI PRODOTTI IN POLVERE, ABRASIVI, SPUGNETTE ABRASIVE O UTENSILI APPUNTITI. Assolutamente da evitare

l’uso di candeggina, ammoniaca, acidi e solventi in genere come acetone. Per la pulizia dei vetri-cristalli, usare un comune detergente per vetri/specchi associato a panni in microfibra o in cotone.

PIANI - MENSOLE - PIATTI DOCCIA IN MARMO

Per la pulizia dei marmi si può utilizzare un detergente liquido, neutro, oppure detergenti specifici per le pietre naturali, non abrasivi, diluiti in acqua tiepida, applicati con panno in microfibra. NON UTILIZZARE MAI PRODOTTI ACIDI O SOLVENTI, in quanto tendono a macchiare o modificare l’aspetto dei materiali.

LAVABI

Per la pulizia delle finiture con metalli preziosi si raccomanda di utilizzare alcool o detergenti per vetro/specchi associati a panni in microfibra o in cotone.

Sono ASSOLUTAMENTE DA NON UTILIZZARE prodotti contenenti acidi di qualsiasi natura e/o spugne e panni abrasivi.

GAMBE METALLICHE E PARTICOLARI IN METALLO

Per la pulizia delle gambe con finiture cromate o ramate lavare esclusivamente con acqua e sapone neutro, risciacquare ed asciugare con un panno morbido. Evitare assolutamente l’impiego di alcool, solventi, detersivi contenenti sostanze corrosive o acide (acido cloridrico, formico, acetico, fosforico), spugne abrasive e tamponi con fili metallici.

LAMPADE E SPECCHI INGRANDITORI IN CERAMICA

Per la pulizia della ceramica si raccomanda di utilizzare alcool o detergenti per vetro/specchi associati a panni in microfibra o in cotone.

Sono ASSOLUTAMENTE DA NON UTILIZZARE prodotti contenenti acidi di qualsiasi natura e/o spugne e panni abrasivi.

SPECCHI

Per la pulizia si raccomanda di utilizzare alcool o detergenti per vetro/specchi associati a panni in microfibra. Sono ASSOLUTAMENTE DA NON UTILIZZARE prodotti contenenti acidi di qualsiasi natura e/o spugne e panni abrasivi.

VASCHE

Per la pulizia delle parti esterne laccate si può utilizzare un detergente liquido, neutro, non abrasivo, diluito in acqua tiepida, applicato con panno in microfibra. NON UTILIZZARE MAI PRODOTTI IN POLVERE, ABRASIVI, SPUGNETTE ABRASIVE O UTENSILI APPUNTITI. Assolutamente da evitare l’uso di candeggina, ammoniaca, acidi e solventi in genere come acetone. Per la pulizia del catino in acrilico, utilizzare un detergente bagno specifico, applicato con panno in microfibra, NON ABRASIVO.

DOCCE

Per la pulizia delle pareti doccia utilizzare un detergente Bagno specifico, applicato con panno in microfibra, NON ABRASIVO.

RUBINETTERIE - SIFONI - PILETTE

Per una corretta pulizia di rubinetti, sifoni, pilette, lavare esclusivamente con acqua e sapone neutro, risciacquare ed asciugare con un panno morbido. Evitare assolutamente l’impiego di alcool, solventi, detersivi contenenti sostanze corrosive o acide (acido cloridrico, formico, acetico, fosforico), spugne abrasive e tamponi con fili metallici.

TABLES - LACQUERED TOPS - CABINETS - SHELVES

- Do not use outdoors

- Avoid direct exposure to the sun’s rays for long periods of time

- Avoid prolonged contact with lotions, cosmetics or concentrated detergents, however neutral, as they may damage the lacquering.

For ordinary cleaning of glossy lacquered parts, use only warm water and a neutral detergent; do not use abrasive cleaning products or corrosive lotions (acetone, anti-lime scale products). For the glass parts we recommend methylated spirit or special cleaners for glass/mirrors and a microfiber cloth.

VANITY TOPS, SHELVES AND SHOWER TRAYS IN MARBLE

To clean the marble parts use only warm water and a neutral detergent or special cleaners for natural stones and a microfiber cloth. Never use acid or corrosive products as they stain and damage the material.

WASHBASINS

To clean precious metal finishes, we suggest methylated spirit or special cleaners for glass/mirrors and microfibre or cotton cloths.

NEVER EVER use products containing any sort of acid and/or abrasive cloths.

ALUMINIUM LEGS AND DETAILS

To clean the chrome or copper finished legs do use only warm water with a neutral detergent, rinse and dry with a soft cloth. do not use alcohol, solvents, abrasive cleaning products or corrosive lotions (hydrochloric, formic, acetic or phosphoric acid), abrasive sponges or buffer with metal strings.

CERAMIC LIGHT FIXTURES AND MAGNIFYING MIRRORS

When cleaning ceramics we recommend using methylated spirit or special cleaners for glass/mirrors and a microfiber or cotton cloth. NEVER EVER use products containing any sort of acid and/or abrasive cloths.

MIRRORS

For the glass parts we recommend methylated spirit or special cleaners for glass/mirrors and a microfiber cloth. NEVER EVER use products containing any sort of acid and/or abrasive cloths.

BATHTUBS

To clean the external glossy lacquered parts, use a neutral detergent diluted with warm water and a microfiber cloth. NEVER USE ABRASIVE CLEANING PRODUCTS OR SPONGES OR SHARP TOOLS. Please avoid bleach or corrosive lotions (acetone, anti-lime scale products). To clean the acrylic basin please use a specific detergent and a microfiber cloth, NOT ABRASIVE.

SHOWER WALLS

To clean the shower walls please use a specific detergent and a microfiber cloth, NOT ABRASIVE.

TAPS - SIPHONS - WASTES

To clean mixers, wastes and siphons do use only warm water with a neutral detergent, rinse and dry with a soft cloth. Do not use alcohol, solvents, abrasive cleaning products or corrosive lotions (hydrochloric, formic, acetic or phosphoric acid), abrasive sponges or buffer with metal strings.

THE WANDERS COLLECTION

CONSOLE - TOP LACCATI - MOBILI CONTENITORI - MENSOLE

- Non usare in esterno

- Evitare l’esposizione diretta ai raggi solari per lungo tempo

- Evitare il contatto prolungato con lozioni, prodotti cosmetici o detergenti anche neutri concentrati che possono rovinare la laccatura.

Per la pulizia delle finiture laccate LUCIDE e OPACHE si può utilizzare un detergente liquido, neutro, non abrasivo, diluito in acqua tiepida, applicato con panno in microfibra. NON UTILIZZARE MAI PRODOTTI IN POLVERE, ABRASIVI, SPUGNETTE ABRASIVE O UTENSILI APPUNTITI. Assolutamente da

evitare l’uso di candeggina, ammoniaca, acidi e solventi in genere come acetone. Per la pulizia dei vetri-cristalli, usare un comune detergente per vetri/specchi associato a panni in microfibra o in cotone.

PIANI IN VETRO

Per la pulizia dei piani in vetro si può utilizzare un detergente liquido, neutro, diluito in acqua tiepida, oppure detergenti specifici per i vetri-specchi (es. Vetril), non abrasivi, applicati con panno in microfibra. NON UTILIZZARE MAI PRODOTTI ACIDI O SOLVENTI, in quanto potrebbero rovinare la superficie o la verniciatura.

LAVABI

Per la pulizia della ceramica si raccomanda di utilizzare alcool o detergenti bagno specifici, associati a panni in microfibra o in cotone.

Si sconsiglia l’uso di prodotti contenenti acidi di qualsiasi natura e/o spugne e panni abrasivi.

PARTICOLARI IN METALLO

Per la pulizia di parti e componenti metalliche cromate o verniciate, utilizzare esclusivamente acqua e sapone neutro, risciacquare ed asciugare con un panno morbido. Evitare assolutamente l’impiego di alcool, solventi, detersivi contenenti sostanze corrosive o acide (acido cloridrico, formico, acetico, fosforico), spugne abrasive e tamponi con fili metallici.

VASCHE

Per la pulizia della vasca si può utilizzare un detergente liquido, neutro, non abrasivo, diluito in acqua tiepida, applicato con panno in microfibra. NON UTILIZZARE MAI PRODOTTI IN POLVERE, ABRASIVI, SPUGNETTE ABRASIVE O UTENSILI APPUNTITI. Assolutamente da evitare l’uso di candeggina, ammoniaca, acidi e solventi in genere come acetone.

RUBINETTERIE - SIFONI - PILETTE

Per una corretta pulizia di rubinetti, sifoni, pilette, lavare esclusivamente con acqua e sapone neutro, risciacquare ed asciugare con un panno morbido. Evitare assolutamente l’impiego di alcool, solventi, detersivi contenenti sostanze corrosive o acide (acido cloridrico, formico, acetico, fosforico), spugne abrasive e tamponi con fili metallici.

TABLES - LACQUERED TOPS - CABINETS - MIRRORS

- Do not use outdoors

- Avoid direct exposure to the sun’s rays for long periods of time

- Avoid prolonged contact with lotions, cosmetics or concentrated detergents, however neutral, as they may damage the lacquering.

For ordinary cleaning of glossy or matte lacquered parts, use warm water and a neutral detergent with a microfiber cloth; do not use abrasive cleaning products or sponges or sharp tools. Please avoid bleach or corrosive lotions (acetone, anti-lime scale products). For the glass parts we recommend methylated spirit or special cleaners for glass/mirrors and a microfiber cloth.

GLASSTOPS

To clean the glass parts use warm water and a neutral detergent or special cleaners for glass/mirrors and a microfiber cloth. NEVER USE CORROSIVE LOTIONS OR SOLVENTS as they can damage the surface or the lacquering.

WASHBASINS

When cleaning ceramics we recommend using methylated spirit or special cleaners for bath and a microfiber or cotton cloth. NEVER EVER use products containing any sort of acid and/or abrasive cloths.

METALLIC PARTS

To clean the chrome finished and metallic parts do use only warm water with a neutral detergent, rinse and dry with a soft cloth. Do not use alcohol, solvents, abrasive cleaning products or corrosive lotions (hydrochloric, formic, acetic or phosphoric acid), abrasive sponges or buffer with metal strings.

BATHTUBS

For ordinary cleaning use warm water and a neutral detergent with a microfiber cloth; NEVER USE ABRASIVE CLEANING PRODUCTS OR SPONGES OR SHARPTOOLS. Please avoid bleach or corrosive lotions (acetone, anti-lime scale products).

TAPS - SIPHONS - WASTES

To clean mixers, wastes and siphons do use only warm water with a neutral detergent, rinse and dry with a soft cloth. Do not use alcohol, solvents, abrasive cleaning products or corrosive lotions (hydrochloric, formic, acetic or phosphoric acid), abrasive sponges or buffer with metal strings.

THE NENDO COLLECTION

LAVABI IN LEGNO

- Non posizionare vicino a fonti di calore
- Non usare in esterno
- Evitare l’esposizione diretta ai raggi solari per lungo tempo
- Usare acqua miscelata, temperatura massima 60°C (140°F)
- Utilizzare il piattino in ceramica in dotazione come portasapone per evitare il contatto continuo di qualsiasi tipo di sapone anche neutro con il legno
- Evitare il contatto prolungato con lozioni, prodotti cosmetici o detergenti anche neutri concentrati che possono essere assorbiti dal legno.
- Evitare il ristagno di acqua: la piletta in dotazione è a scarico libero per garantire un costante deflusso dell’acqua. La staffa a corredo è munita di regolazioni per la perfetta ‚messa in bolla’. Una installazione non corretta potrebbe provocare ristagni d’acqua all’interno del catino e a lungo andare depositi di calcare e MUFFE. Bisazza declina ogni responsabilità in caso di installazione NON CORRETTA del lavabo o in caso di sostituzione del sifone e della piletta con prodotti non originali.

IMPORTANTE: un utilizzo continuo del prodotto in legno garantisce le condizioni di temperatura e umidità idonee a preservarlo nel tempo da eventuali danni; piccole crepe o leggere fessurazioni superficiali potrebbero comparire nel tempo con l’utilizzo, ma in nessun caso precludono l’utilizzo del prodotto o la tenuta all’acqua.

- Non lasciare il lavabo inutilizzato per lunghi periodi.

Per la pulizia ordinaria, usare solo acqua e detergenti neutri con panni in microfibra. Non utilizzare prodotti abrasivi o lozioni corrosive (acetone, anticalcare).

Ogni 6-12 mesi, provvedere ad effettuare una manutenzione straordinaria, utilizzando il kit di manutenzione fornito a corredo. Particolare attenzione va data alle zone a diretto contatto con l’acqua (fondo e pareti interne al catino).

Laddove fosse necessario (al comparire di escrescenze, piccole crepe, depositi di sporco duri da rimuovere...), provvedere al ripristino del film protettivo con la vernice all’acqua fornita nel kit, seguendo attentamente le istruzioni in esso contenute.

VASCA

- Non posizionare vicino a fonti di calore
- Non usare in esterno
- Evitare l’esposizione diretta ai raggi solari per lungo tempo
- Usare acqua miscelata, temperatura massima 60°C (140°F)
- Evitare il contatto prolungato con lozioni, prodotti cosmetici o detergenti anche neutri concentrati che possono essere assorbiti dal legno.
- Evitare il ristagno di acqua: la vasca è dotata di piedini di regolazione per la perfetta ‚messa in bolla’. Una installazione non corretta potrebbe provocare ristagni d’acqua all’interno del catino e a lungo andare depositi di calcare e MUFFE. Bisazza declina ogni responsabilità in caso di installazione NON CORRETTA.

IMPORTANTE: un utilizzo continuo del prodotto in legno garantisce le condizioni di temperatura e umidità idonee a preservarlo nel tempo da eventuali danni; piccole crepe o leggere fessurazioni superficiali potrebbero comparire nel tempo con l’utilizzo, ma in nessun caso precludono l’utilizzo del prodotto o la tenuta all’acqua.

- Non lasciare la vasca inutilizzata per lunghi periodi (oltre 2 mesi).
- Svuotare e sciacquare il prodotto dopo ogni singolo utilizzo (utilizzo massimo 2-3 ore)

Per la pulizia ordinaria, usare solo acqua e detergenti neutri con panni in microfibra. Non utilizzare prodotti abrasivi o lozioni corrosive (acetone, anticalcare).

Ogni 6-12 mesi, provvedere ad effettuare una manutenzione straordinaria, utilizzando il kit di manutenzione fornito a corredo. Particolare attenzione va data alle zone a diretto contatto con l’acqua (fondo e pareti interne al catino).

Laddove fosse necessario (al comparire di escrescenze, piccole crepe, depositi di sporco duri da rimuovere...), provvedere al ripristino del film protettivo con la vernice all’acqua fornita nel kit, seguendo attentamente le istruzioni in esso contenute.

SPECCHI - CABINET - SGABELLI - MENSOLE - PORTASALVIETTE

- Non usare in esterno
- Evitare l’esposizione diretta ai raggi solari per lungo tempo
- Evitare il contatto prolungato con lozioni, prodotti cosmetici o detergenti anche neutri concentrati che possono essere assorbiti dal legno.

Per la pulizia ordinaria, usare solo acqua e detergenti neutri con panni in microfibra. Non utilizzare prodotti abrasivi o lozioni corrosive (acetone, anticalcare).

TOP LAVABO IN CRISTALPLANT®

- Non usare in esterno
 - Evitare il contatto prolungato con lozioni, prodotti cosmetici o detergenti anche neutri concentrati che possono macchiare il legno (che possono essere assorbiti dal legno).
 - La piletta in dotazione è a scarico libero per garantire un costante deflusso dell’acqua. Bisazza declina ogni responsabilità in caso di installazione del lavabo con sifone e piletta non originali.
- Per la pulizia ordinaria del legno, usare solo acqua e detergenti neutri; non utilizzare prodotti abrasivi o lozioni corrosive (acetone, anticalcare).
Per la pulizia ordinaria del Cristalplant®, usare un panno umido imbevuto dei comuni detergenti, avendo cura di risciacquare bene la superficie.
Per la pulizia straordinaria del Cristalplant®, utilizzare la spugnetta abrasiva in dotazione e seguire le indicazioni contenute nel kit di manutenzione.

LAVABO IN MINERALMARMO®

- Non usare in esterno
 - Evitare il contatto prolungato con lozioni, prodotti cosmetici o detergenti anche neutri concentrati che possono macchiare il legno (che possono essere assorbiti dal legno).
 - La piletta in dotazione è a scarico libero per garantire un costante deflusso dell’acqua. Bisazza declina ogni responsabilità in caso di installazione del lavabo con sifone e piletta non originali.
- Prendersi cura del Mineralmarmo® è facile e veloce. Per rimuovere la maggior parte di macchie, il calcare e lo sporco che normalmente si depositano

sulla superficie, è sufficiente pulire con un panno o una spugna non abrasiva umida e comuni detergenti non abrasivi (meglio in gel). Al termine della pulizia risciacquare bene la superficie.

Per la pulizia evitare l’uso di detergenti e spugne abrasive. Non usare raschietti metallici. Questo prodotto ha una buona resistenza al calore, tuttavia evitare di appoggiare sulla superficie oggetti roventi o di scolare liquidi bollenti. Si sconsiglia l’uso di solventi chimici aggressivi quali acetone, trielina, solventi, acidi e basi forti. Alcune sostanze come inchiostro, cosmetici e tinture possono rilasciare coloranti sulla superficie: evitare che vengano a contatto con la superficie. Non appoggiare sigarette accese, non tagliare direttamente sulla superficie.

Per la pulizia ordinaria del legno, usare solo acqua e detergenti neutri; non utilizzare prodotti abrasivi o lozioni corrosive (acetone, anticalcare).

LAMPADE E LAMPADARI

Per una corretta pulizia di Lampade e Lampadari, utilizzare esclusivamente panni in microfibra inumiditi con acqua ed eventualmente sapone neutro diluito, ed asciugare con un panno morbido. Evitare assolutamente l’impiego di acqua corrente, alcool, solventi, detersivi contenenti sostanze corrosive o acide (acido cloridrico, formico, acetico, fosforico), spugne abrasive e tamponi con fili metallici.

RUBINETTERIE - SIFONI - PILETTE

Per una corretta pulizia di rubinetti, sifoni, pilette, lavare esclusivamente con acqua e sapone neutro, risciacquare ed asciugare con un panno morbido. Evitare assolutamente l’impiego di alcool, solventi, detersivi contenenti sostanze corrosive o acide (acido cloridrico, formico, acetico, fosforico), spugne abrasive e tamponi con fili metallici.

WOODEN SINKS

- Do not position close to heat sources
 - Do not use outdoors
 - Avoid direct exposure to the sun’s rays for long periods of time
 - Use with blended hot and cold water at a maximum temperature of 60°C (140°F)
 - Use the ceramic soap dish provided to avoid ongoing contact of any kind of soap, however neutral, with the wood
 - Avoid prolonged contact with lotions, cosmetics or concentrated detergents, however neutral, as they may be absorbed by the wood
 - Do not leave stagnant water in the sink: the drain is open, without a stopper, to ensure a constant flow of water.The bracket provided may be adjusted to ensure perfectly level installation. Incorrect installation may cause water to stagnate within the basin and over time may result in deposits of lime scale and MOLD. Bisazza shall not be held liable for any INCORRECT installation of the sink or for use of a drain and drain trap different from the original ones.
- IMPORTANT:** continuous use of the wooden product guarantees the best temperature and humidity conditions for preserving it from damage over time; small cracks or slight surface splitting might appear over time, which does not in any case whatsoever preclude use of the product or the water seal. Do not leave the sink unused for prolonged periods.

For ordinary cleaning, use only neutral soap and water. Do not use abrasive products or corrosive lotions (acetone, anti-lime scale products). Every 6-12 months, use the kit provided for special maintenance, paying particular attention to areas in direct contact with water (inner walls and bottom of the basin).

Wherever necessary (with the appearance of growths, small cracks, stubborn dirt deposits...), restore the protective film using the water-based paint supplied with the kit and carefully following the instructions provided.

BATHTUB

- Do not position close to heat sources
- Do not use outdoors
- Avoid direct exposure to the sun’s rays for long periods of time
- Use with blended hot and cold water at a maximum temperature of 60°C (140°F)
- Avoid prolonged contact with lotions, cosmetics or concentrated detergents, however neutral, as they may be absorbed by the wood
- Do not leave stagnant water: the tub is provided with adjustable feet to ensure perfectly level installation. Incorrect installation may cause water to stagnate within the basin and over time may result in deposits of lime scale and MOLD. Bisazza shall not be held liable for any INCORRECT installation of the tub.

IMPORTANT: continuous use of the wooden product guarantees the best temperature and humidity conditions for preserving it from damage over time; small cracks or slight surface splitting might appear over time, which does not in any case whatsoever preclude use of the product or the water seal. Do not leave the tub unused for prolonged periods (more than 2 months).

Empty and rinse the tub after each use (use for a maximum of 2-3 hours).
For ordinary cleaning, use only neutral soap and water. Do not use abrasive products or corrosive lotions (acetone, anti-lime scale products). Every 6-12 months, use the kit provided for special maintenance, paying particular attention to areas in direct contact with water (inner walls and bottom of the basin).

Wherever necessary (with the appearance of growths, small cracks, stubborn dirt deposits...), restore the protective film using the water-based paint supplied with the kit and carefully following the instructions provided.

MIRRORS - CABINETS - STOOL - SHELVES - TOWEL RACKS

- Do not use outdoors
 - Avoid direct exposure to the sun’s rays for long periods of time
 - Avoid prolonged contact with lotions, cosmetics or concentrated detergents, however neutral, as they may be absorbed by the wood
- For ordinary cleaning, use only neutral soap and water. Do not use abrasive products or corrosive lotions (acetone, anti-lime scale products).

CRISTALPLANT® SINK COUNTERTOP

- Do not use outdoors
 - Avoid prolonged contact with lotions, cosmetics or concentrated detergents, however neutral, as they may stain the wood (may be absorbed by the wood).
 - The drain provided is open, without a stopper, to ensure a constant flow of water. Bisazza shall not be held liable for damage if the sink is installed with a drain and drain trap different from the original ones.
- For ordinary cleaning of wood, use only water and a neutral detergent; do not use abrasive cleaning products or corrosive lotions (acetone, anti-lime scale products).
For ordinary cleaning of Cristalplant®, use a soft cloth dampened with an ordinary cleaning product, and be sure to rinse the surface well afterwards.
For in-depth cleaning of Cristalplant®, use the abrasive pad provided and follow the instructions in the maintenance kit.

MINERALMARMO® WASHBASIN

- Do not use outdoors
- Avoid prolonged contact with lotions, cosmetics or concentrated detergents, however neutral, as they may stain the wood (may be absorbed by the wood).

Foto Lorenzo Ceretta

Nienke Kluder

Paolo Veclani

Progetto grafico Paolo Rinaldi

Claudia Carrarini